

verope ®

# TECHNICAL BROCHURE

verope® special wire ropes

verotech 10



<b>1.</b>	<b>ROPE REQUIREMENTS FROM THE CRANE VIEW</b>	<b>4</b>
<b>1.1</b>	<b>Wire rope "alambre"</b>	<b>4</b>
1.1.1	Material	4
1.1.2	Manufacturing process	4
1.1.3	Wire surfaces	4
1.1.4	Wire of the wire	4
1.1.5	Resistance to elongation of the wire	4
<b>1.2</b>	<b>Wire rope strand</b>	<b>5</b>
1.2.1	Length of the strand	5
1.2.2	Direction of the strand	5
1.2.3	Diameter of the strand	6
1.2.4	Strand designation	6
1.2.5	Compactness of strands	8
1.2.6	Filter of the strand	8
<b>1.3</b>	<b>Wire rope cable</b>	<b>10</b>
1.3.1	Diameter of the cable	10
1.3.2	Measuring device and its correct application	10
1.3.3	Types of measuring devices	11
1.3.4	Direction of the cable	12
1.3.5	Strand designation	12
1.3.6	Filter of the cable	12
1.3.7	Types of wire ropes	13
1.3.8	Cable end connections	14
1.3.9	Types of cables (date of designation according to EN 12385-2)	14
1.3.10	Special wire ropes	14
1.3.11	Ball-bearing wire ropes	14
1.3.12	Wire rope lubrication	16
<b>2.</b>	<b>ROPE CHARACTERISTICS</b>	<b>17</b>
<b>2.1</b>	<b>Resistance to elongation</b>	<b>17</b>
<b>2.2</b>	<b>Resistance to fatigue</b>	<b>17</b>
<b>2.3</b>	<b>Flexibility</b>	<b>17</b>
<b>2.4</b>	<b>Efficiency and efficiency</b>	<b>18</b>
<b>2.5</b>	<b>Resistance to wear</b>	<b>18</b>
<b>2.6</b>	<b>Deformation and deformation</b>	<b>20</b>
2.6.1	Modulus of elasticity	20
2.6.2	Ball stability	22
2.6.3	Structural stability	22
2.6.4	Reduction of diameter of special wire rope	22
<b>3.</b>	<b>ROPE END CONNECTIONS</b>	<b>23</b>
<b>3.1</b>	<b>Elasticity</b>	<b>23</b>
<b>3.2</b>	<b>Resistance to elongation</b>	<b>24</b>
3.2.1	Resistance to elongation of the rotating	25
<b>3.3</b>	<b>Bending fatigue of wire rope</b>	<b>25</b>
3.3.1	Bending fatigue of wire rope in plastic sleeves	30
3.3.2	Bending fatigue of wire rope in plastic sleeves	30
3.3.3	Bending fatigue in dependence of the diameter of the cable	31
3.3.4	Bending fatigue in dependence of the tension pull	32

3.3.5	Bending fatigue in dependence of the sheave diameter	32
<b>3.4</b>	<b>Deformation behavior</b>	<b>33</b>
3.4.1	Modulus of elasticity	34
3.4.2	Elongation	35
3.4.3	Diameter reduction	36
3.4.4	Lateral stability with and without load	37
<b>3.5</b>	<b>Rotational behavior</b>	<b>39</b>
<b>3.6</b>	<b>Flexibility</b>	<b>40</b>
<b>3.7</b>	<b>Efficiency factor</b>	<b>40</b>
<b>4.</b>	<b>DISCARD CRITERIA (ISO 4309)</b>	<b>42</b>
<b>5.</b>	<b>CRANE COMPONENTS</b>	<b>44</b>
<b>5.1</b>	<b>Drums</b>	<b>44</b>
<b>5.2</b>	<b>Sheaves</b>	<b>44</b>
<b>6.</b>	<b>CHOOSE THE RIGHT ROPE FOR YOUR APPLICATION</b>	<b>46</b>
<b>6.1</b>	<b>Application view</b>	<b>46</b>
<b>6.2</b>	<b>Rope view</b>	<b>47</b>
6.2.1	"Hoist Application"	47
6.2.1.1	Usage of a swivel on hoist ropes	48
6.2.2	More crane applications	50
<b>6.3</b>	<b>Application of regular (or ordinary) lay and lang's lay ropes</b>	<b>52</b>
6.3.1	Ordinary lay ropes	52
6.3.2	Lang's lay ropes	52
<b>7.</b>	<b>ROPE REQUIREMENTS FROM THE CRANE VIEW</b>	<b>54</b>
<b>8.</b>	<b>ROPE END CONNECTIONS</b>	<b>56</b>
<b>8.1</b>	<b>Points of reference to determine the rope length precisely</b>	<b>56</b>
<b>8.2</b>	<b>Efficiency factor <math>K_T</math> of rope end connections</b>	<b>57</b>
<b>9.</b>	<b>GENERAL INFORMATION</b>	<b>58</b>
<b>9.1</b>	<b>Handling and Storage of ropes</b>	<b>58</b>
9.1.1	Handling of reels	58
9.1.2	Rope Storage	58
<b>9.2</b>	<b>Installation of wire ropes</b>	<b>59</b>
9.2.1	Control of the new rope	59
9.2.2	Inspection of sheave grooves	60
9.2.3	Rope Installation Process	61
9.2.4	Initial operation after installation process	62
9.2.5	Rope installation with multi-layer spooling	62
9.2.6	Importance of preliminary tension of ropes with multi-layer spooling	63
<b>10.</b>	<b>SAFETY INSTRUCTIONS</b>	<b>64</b>
<b>11.</b>	<b>USE OF METRICAL ROPES ON IMPERIAL CRANES AND OF IMPERIAL ROPES ON METRICAL CRANES</b>	<b>66</b>
<b>12.</b>	<b>VEROPE® SERVICE AND R&amp;D CENTER</b>	<b>68</b>
<b>13.</b>	<b>WORLDWIDE SERVICE AND DISTRIBUTION</b>	<b>70</b>



# ROPE TECHNOLOGY BASICS

## 1.1 ALL ABOUT "WIRE"

### Raw material

Wires are usually made from specified carbon steel. The carbon content is between 0,4% and 1%, the manganese content between 0,3% and 1%, the silicon content between 0,1% and 0,3% and the contents of phosphorus and sulphur each under 0,45%.

### Manufacturing process

Wire rod of 6 to 9mm diameter, the raw material, will be transformed to the desired strength, diameter and shape by rolling or drawing in a cold forming process.

### Wire surfaces

Galvanized wires are zinc coated by going through a bath of liquid zinc. The wire is called "finally galvanized" if it does not get drawn further after this process. If the wire cross section is further reduced after this process, the wire is called "drawn galvanized".

Bright wires, uncoated, are indicated with the capital letter "U", whereas zinc coated wires are divided into class "A" and class "B", depending on the the zinc weight coating.

### Wire forms

A distinction is made between the wire shapes. A round wire is a wire with a round cross section. Every wire that has a non-round cross section is called a profiled wire. There are oval wires, flat wires, Z- and S-profiled wires, H-shaped wires, trapezoidal or wedge shaped wires and triangular wires. Profiled wires are produced by drawing or rolling processes.

### Wire tensile strength

The tensile strength of a wire is defined as the maximum tensile force a wire can stand in longitudinal direction without breaking, divided by the cross section of the wire. The nominal tensile strength of a wire is a theoretical value, the actual tensile strength of the wire should not fall below the nominal tensile strength and should only exceed it in defined limits. Rope wires with the nominal tensile strengths of 1770 N/mm<sup>2</sup>, 1960 N/mm<sup>2</sup> and 2160 N/mm<sup>2</sup> are commonly used in modern wire ropes.

### Wire strength

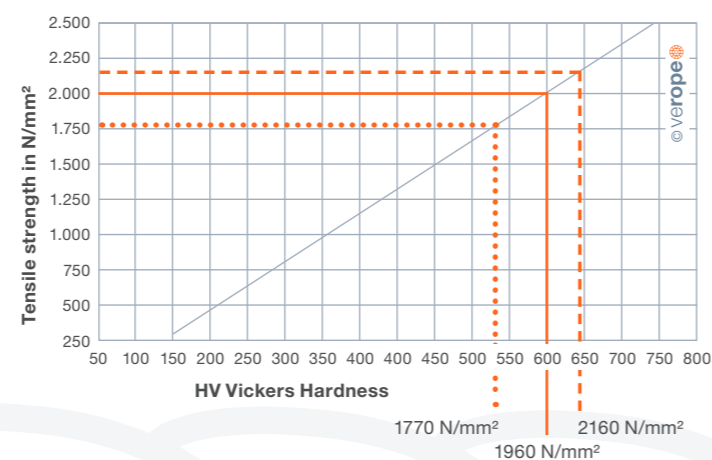

### verope® wire drawing process

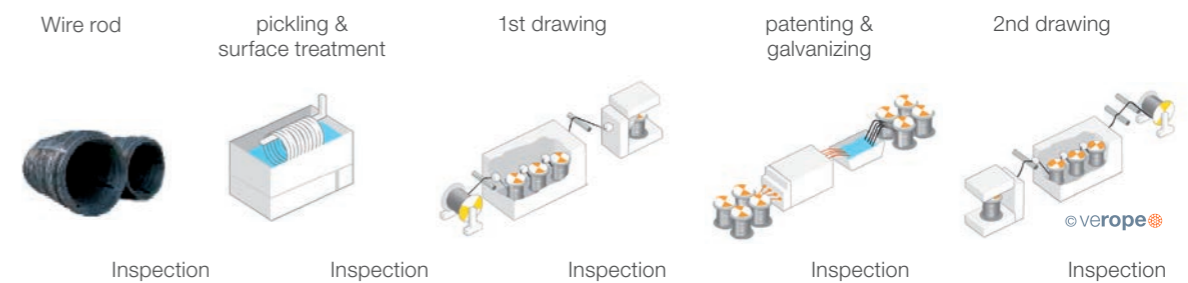

### Unique special wire ropes

- high quality wire rod
- state of the art design
- experienced production & innovative rope tests
- careful development due to computerized wire rope sizing
- manufactured by the world's largest wire product manufacturers using the latest machinery
- due to Kiswire's own wire drawing the raw material is of unmatched quality
- unique design

## 1.2 ALL ABOUT THE STRAND

A strand consists of one or multiple layers of wires, which are wound in a helical shape around an insert (figure 1).

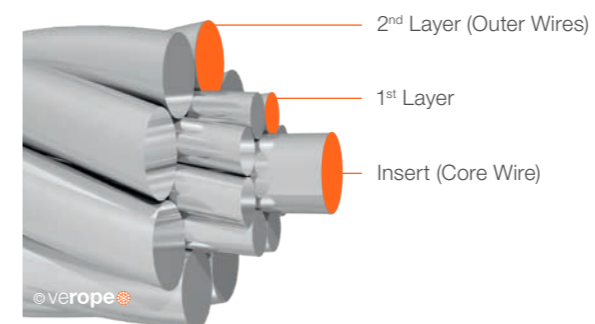

Figure 1: Components of a strand

### Lay length of a strand

The lay length of a strand is generally understood as the pitch of the helical lay of the wires, which means the lengths of a strand at which the wire circulates completely one time.

By varying the lay length, the contact conditions of adjacent wires, the elastic properties and the breaking strength of a strand can be changed.

S



Figure 2: Left hand lay

Z



Figure 3: Right hand lay

### Lay direction of a strand

A distinction is made between right hand and left hand lay strands. The lay direction is left hand, when (moving away from the beholder) the wires are rotated counterclockwise (figure 2).

The lay direction of a strand is right hand, when its wires (moving away from the beholder) are rotated clockwise (figure 3). The lay direction of a strand is often given by small s for the left hand lay strand and by a small z for the right hand lay strand.

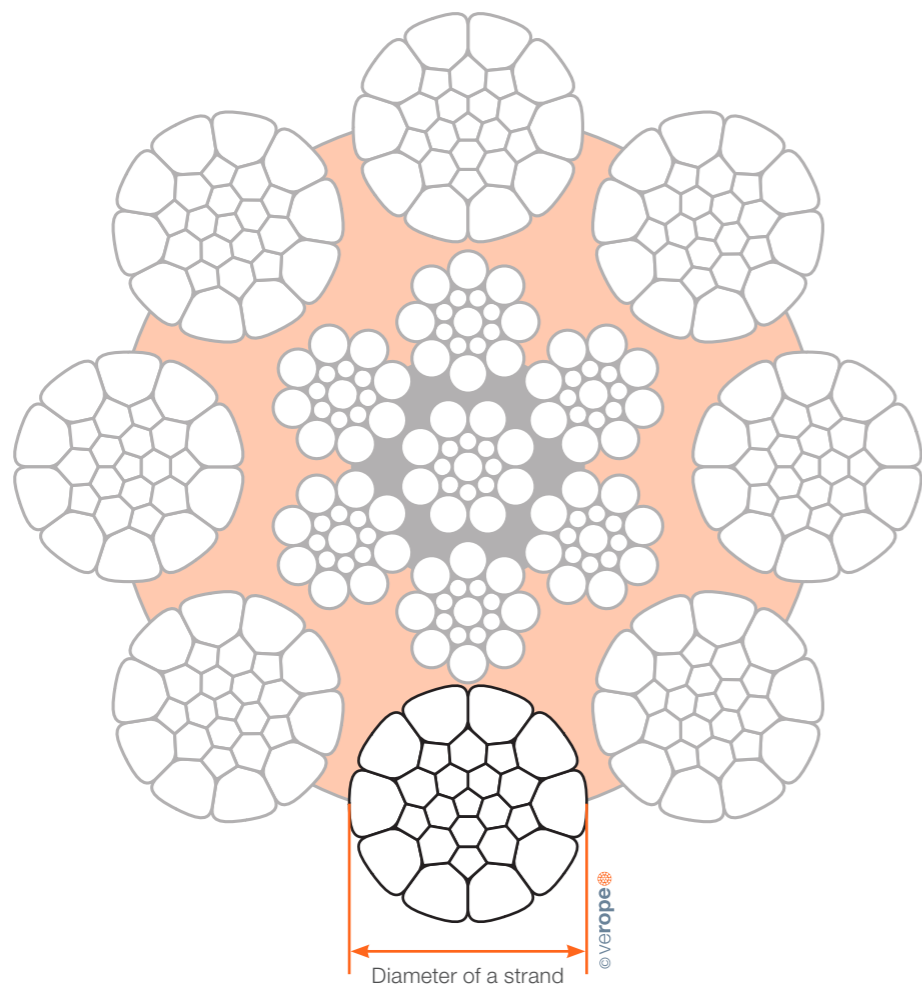

Figure 4: Diameter of a strand

#### Diameter of a strand

The diameter of a strand is the diameter of the smallest enveloped circle, which encloses all wires. The strand diameter is usually measured with a micrometer caliper and is given accurate to 1/100mm (figure 4).

#### Strand design

One understands the formation law by the design of a strand according to which the wires are arranged relative to each other. So all strands of the design Seale have for example the construction 1 - n - n (with n=3, 4, 5, 6, 7, 8, 9) wire layers, which get stranded parallel to each other in a single operation. According to EN 12385-3 these are connected by a minus "-" sign in the designation.

The name of a Seale strand design Seale 17 is therefore 1-8-8, the designation of a strand design Seale 19 is 1-9-9.

The most important strand designs are one-, two and three layer standard strands (figure 5), as well as parallel lay strands of the strand designs Seale, Filler, Warrington and Warrington-Seale (figure 6 & 7).

The two and three-layer standard strands show crossovers between the wires of the different wire layers (figure 5). Here the wire layers get stranded in separate operations in the same direction (designation N) with a same stranding angle but with different lay lengths.

The so called parallel lay strands (Seale, Filler, Warrington, Warrington-Seale) avoid crossovers and create line contact of the wires instead. This happens due to a stranding of all wire layers at once with different stranding angles but the same lay length (figure 6 & 7).

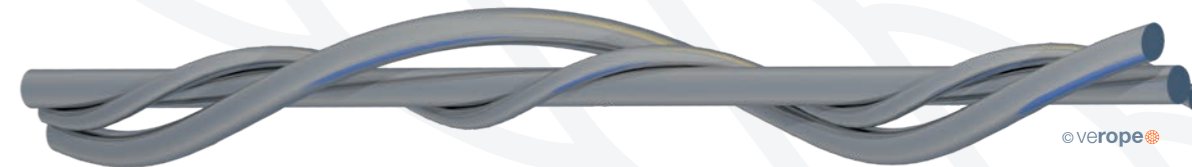
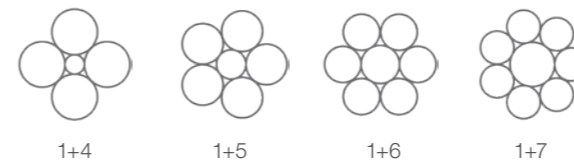

Figure 5: Standard strand

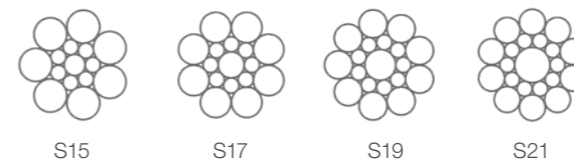

Figure 6: Parallel lay strand

#### 1+N



#### Seale



#### Warrington

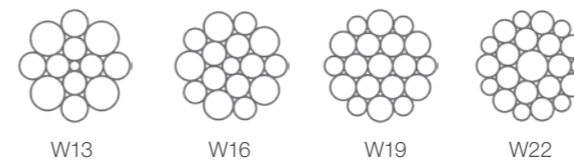

#### Filler

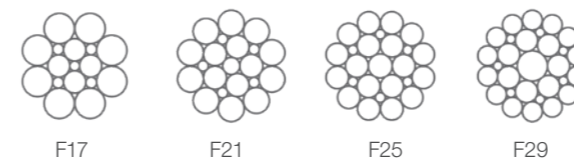

#### Warrington-Seale

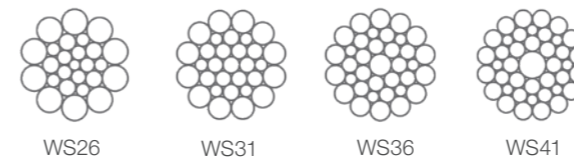

Figure 7: Strand designs

**Compacted round strands**

A compacted round strand starts as a conventional torsion free round wire strand. The strands are compacted either during stranding or in a separate operation afterwards to form a smaller diameter by rolling or drawing. The originally round wires are heavily deformed by both the compacting tool and the adjacent wires (**figure 8**).

**Fill factor of a strand**

The fill factor of a strand is defined as the ratio of the metallic cross section (or as simplified calculation the sum of the single wire cross sections) related to the area of the smallest circle enclosing the strand. The fill factor specifies the amount of space which the strand takes in the rope meaning the quantity of steel.

The fill factors of the most common strands are between 0,70 and 0,82. This means, that the amount of steel in the strand is about 70% to 82%. The fill factors of strands can be considerably increased by compacting.

Usually the fill factor of a strand increases with an increasing number of wires. A Seale 15 strand (1-7-7) for example has a fill factor of about 0,77 and a Seale 19 strand (1-9-9) has a fill factor of about 0,79.



**Figure 8:** Uncompacted and compacted round strands

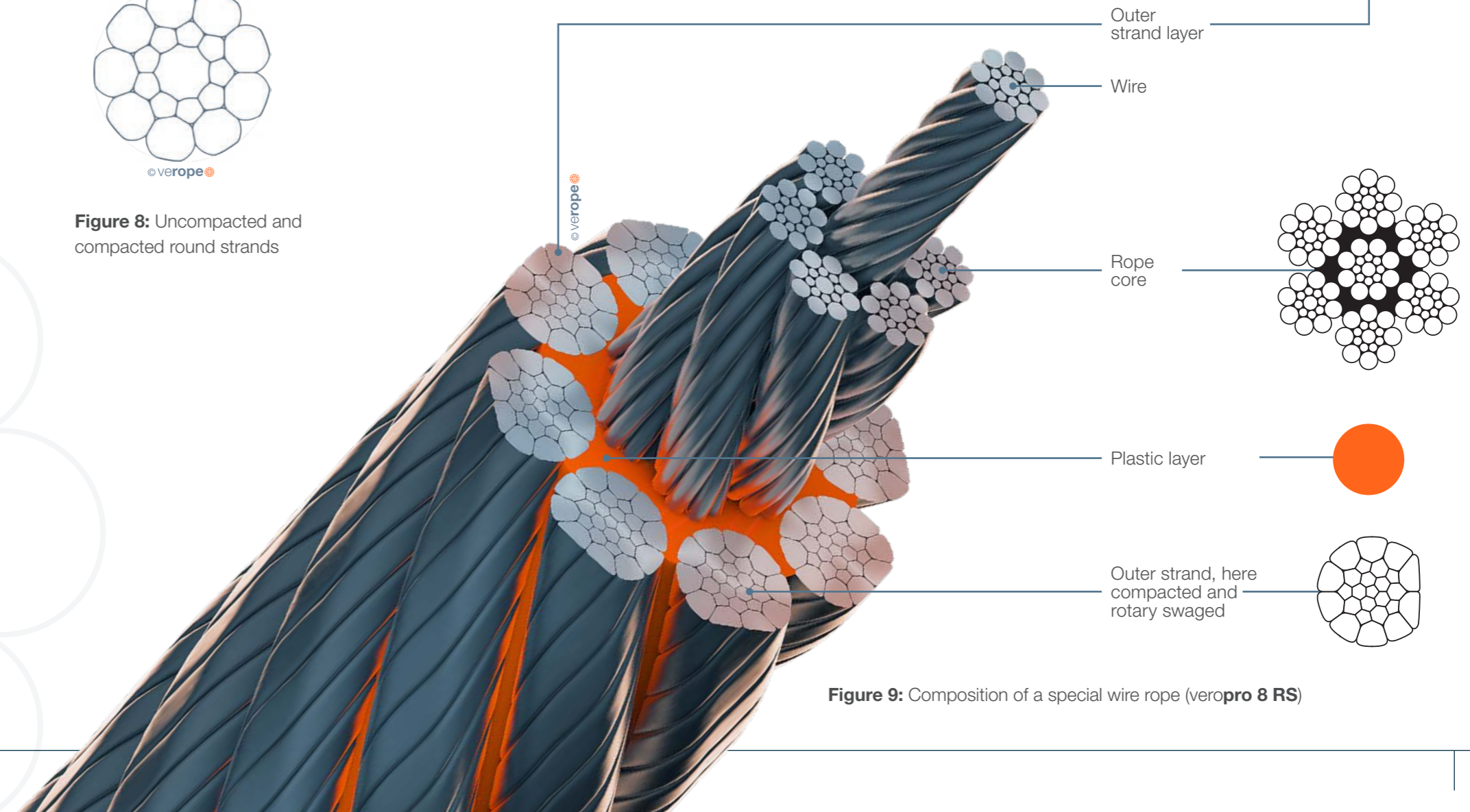
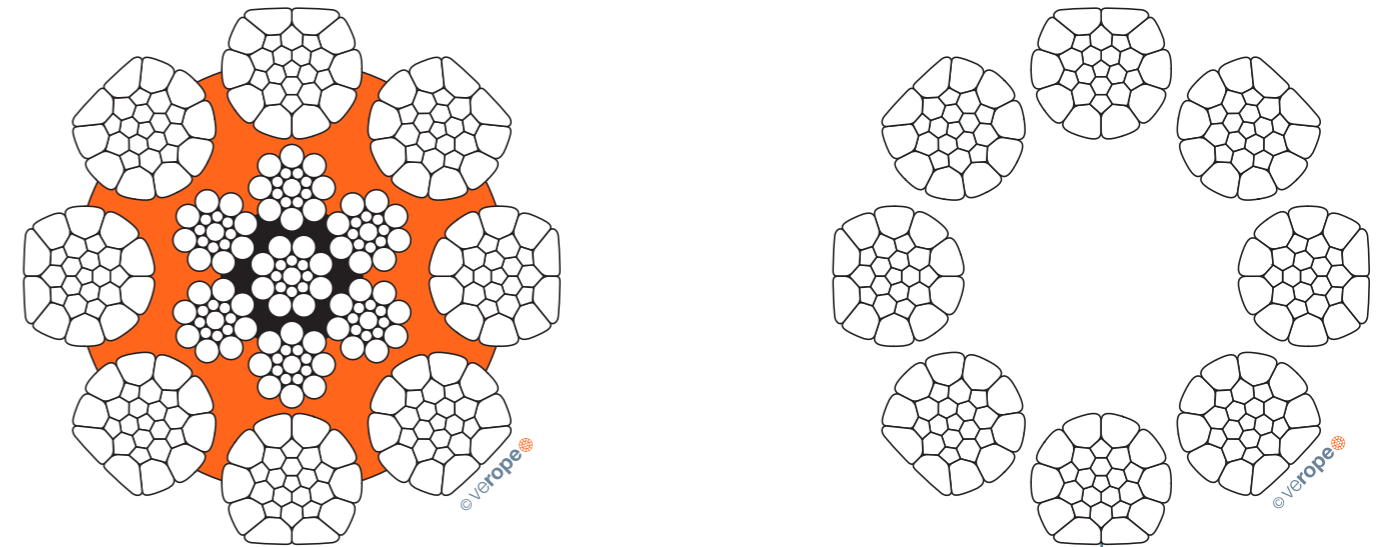

**Figure 9:** Composition of a special wire rope (veropro 8 RS)



## 1.3 ALL ABOUT THE ROPE

### Wire rope diameter

A distinction is made between the nominal rope diameter and the actual rope diameter.

The nominal wire rope diameter is an agreed theoretical value for the diameter of the smallest circle enclosing the outer strands.

The effective rope diameter, also called actual rope diameter, is the diameter of the smallest circle enclosing all outer strands, as measured on the rope itself. The tolerance range for the effective rope diameter is specified in related national and international standards. According to EN 12385-4 it is between -0% and +5% (for nominal rope diameters  $\geq 8\text{mm}$ )

This means that the effective rope diameter upon delivery must neither be smaller, nor 5% bigger than the nominal rope diameter.

The tolerance range is often higher for smaller ropes like 3mm to 7mm nominal diameter.

In the Oil and Gas industry, which is firmly based on US regulations, a tolerance range from -1% to +4% is applied.

The effective rope diameter changes depending on the load applied. Therefore the effective rope diameter should in critical cases be measured on a rope that is loaded with 5% of the calculated breaking strength. verope® produces standard tolerances of +2% to +4% and special tolerances upon request.

### Measuring devices and their correct handling

In order to define the correct effective rope diameter, the correct measuring device has to be used. The measurement should strictly be done over the round ends (circumscribed circle of the rope). If one measures in the strand valleys, the result will be inaccurate. For ropes with an uneven number of outer strands, it is important that the measuring surface covers several strands (**figure 10**).

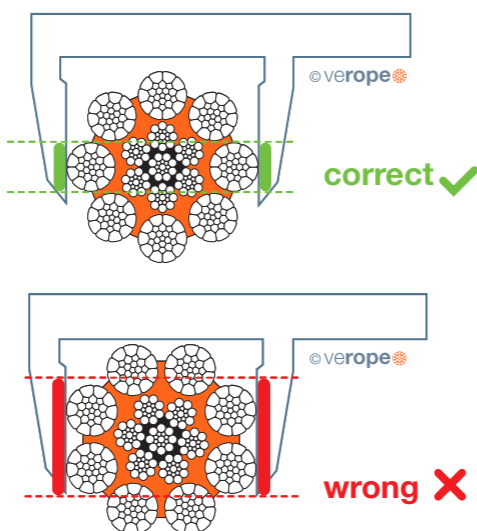

Figure 10: Correct determination of the rope diameter

### Types of measuring devices



Figure 11: Micrometer with wide measuring flanks

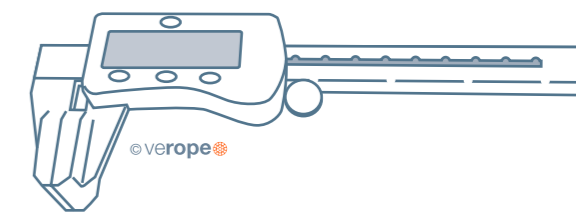

Figure 12: Small caliper with wide measuring flanks

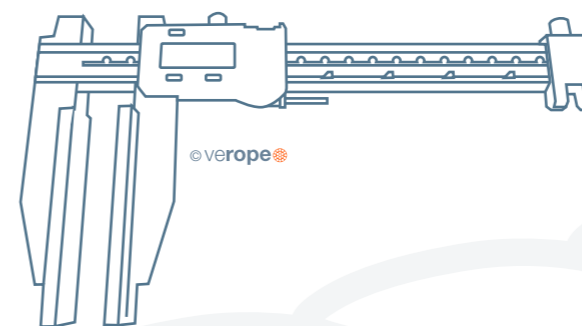
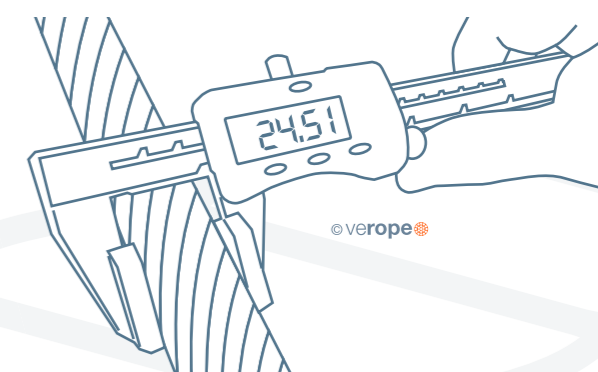

Figure 13: Big caliper with wide measuring flanks





### Lay direction of a wire rope

A distinction is made between right hand and left hand lay ropes.

The lay direction is left hand, when the strands (moving away from the beholder) are rotated counterclockwise (**figure 14**). The lay direction of a rope is right hand, when its strands (moving away from the beholder) are rotated clockwise (**figure 15**).

The lay direction of a rope is often given by a capital S for the left hand lay rope and by a capital Z for the right hand lay rope. Others often use RH for Right Hand and LH for Left Hand lay ropes.



**Figure 14:**  
Left hand lay rope



**Figure 15:**  
Right hand lay rope

### Rope design

By the design of a wire rope, one understands the formation principle according to which the elements of the wire rope (the wires and the strands) are arranged relative to each other. The designation of a fiber core is FC, for an independent steel wire rope core it is IWRC.

As an example all round strand ropes of the 6x19 Warrington design with a fiber core have the construction 6 x [1-6-(6-6)] - FC.

### Fill factor of a rope

The fill factor of a rope is defined as the ratio of the metallic cross section of the rope (or a simplified calculation of the sum of the single wire cross sections) related to the nominal rope diameter. The fill factor specifies which amount of space the wires and strands take in the rope (**figure 16**).

The fill factors of the most common ropes are between 0,46 and 0,75. This means, that the amount of steel in the rope volume is about 46% to 75%. Wire ropes with a wire rope core have higher fill factors than ropes with a fiber core.

A rope of the design 6x25 Filler-FC for example has a fill factor of 0,50 and a rope with a design 6x25 Filler-IWRC has a fill factor of 0,58.

Usually fill factors of wire ropes with a fibre core (FC) decrease with an increasing number of outer strands. A rope of the design 6x25 Filler-FC has a fill factor of 0,50, a rope of the design 8x25 Filler-FC has a fill factor of only 0,445.

Usually fill factors of wire ropes with a wire rope core increase with an increasing number of outer strands. A rope of the design 6x25 Filler-IWRC has a fill factor of 0,58 and a rope of the design 8x25 Filler-IWRC has a fill factor of 0,587.

### Figure 16:

The fill factor of the strand is the proportion of the metallic cross sections (white surfaces) at the metall cross section area of the minimum circumscribed circle (white and grey surfaces).

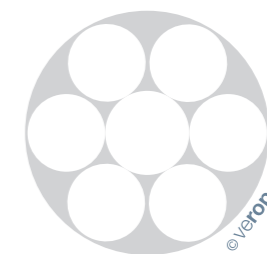

**Figure 16:** Fill factor

Wire ropes that are made of compacted strands have higher fill factors than ropes of uncompacted strands. By compacting and rotary swaging of the rope itself the fill factor can further be increased.

### Lay types of wire ropes

Two lay types are to be considered: Regular or ordinary lay and lang's lay.

In regular lay ropes, the lay direction of the wires in the strands is opposite to the lay direction of the strands in the rope. We distinguish between right hand ordinary lay RHOL (right hand strand, left hand rope, zS) (**figure 17**) and left hand ordinary lay LHOL (left hand strand, right hand rope, sZ) (**figure 18**).

In lang's lay ropes, the lay direction of the wires in the strands is equal to the strands in the rope. We distinguish between left hand lang's lay LHLL (left hand strand, left hand rope, sS) (**figure 19**) and right hand lang's lay RHLL (right hand strand, right hand rope, zZ) (**figure 20**).

### The advantages of regular lay ropes are:

- Better structural stability
- Higher number of broken wires are allowed
- Easier identification of broken wires

### The advantages of lang's lay ropes are:

- Better contact in the groove of the sheaves
- Superior resistance to wear
- Longer lifetime in case of high dead loads
- Considerably better spooling behavior on a multi-layer drum



**Figure 17:**  
Regular lay  
left hand  
(zS)



**Figure 18:**  
Regular lay  
right hand  
(sZ)



**Figure 19:**  
Lang's Lay  
left hand  
(sS)



**Figure 20:**  
Lang's Lay  
right hand  
(zZ)



### Low-tension wire ropes

In the stranding process the initially straight wires are forced into a helical or double-helical form. Therefore, the wires in a rope are always under tension, even in an unloaded rope. Such a rope must be sealed very tightly left and right of the joint before cutting the rope because otherwise the free ends of the wires will spring open.

By using a "preforming tool", the wires and strands can be heavily plastically deformed during the stranding, so they are laying nearly without tension in the rope, the rope now is preformed. The ropemakers consider such ropes to be "dead". Preformed ropes can be cut much easier, also secured by seizings of course, than non-preformed ropes.

### Types of rope cores (abbreviated designations according to EN 12385-2)

Usually wire ropes have either a fiber core (FC) or a steel/wire core. The steel/wire core can be a strand (WC) or a small rope, named as independent wire rope core (IWRC). The IWRC can be made in a separate operation or during the closing operation of the wire rope (PWRC).

The wire core can also have a plastic coating (EPIWRC).

Cores made of compacted strands have the additional designation (K). An independent wire core made of compacted strands is therefore called IWRC (K). A rope closed in a single operation and made out of compacted strands both in the core and the outer strands is called PWRC (K).

### Semi rotation-resistant wire ropes

wire ropes and their free rope end rotate to a greater or lesser extent around its longitudinal axis under the influence of tension. Wire ropes having a core lay direction opposite to the lay direction of the outer strands and 3- or 4-strand regular lay wire ropes rotate considerably less than wire ropes with the same lay direction of the wire core and the outer strands and wire ropes with fiber cores.

According to VDI 2358, a wire rope is semi rotation-resistant when: "the wire rope which turns around its longitudinal axis when subjected to unguided load and/or hardly transmits a torque to the attachment at the end in the event of guided rope ends."

According to ISO 21669 and DIN EN 12385-3: "a rope is considered to be semi rotation resistant if it rotates at least once and at most four times around its axis at a length of  $1000 \times d$  under a load of 20 % of the minimum breaking force. In terms of rotation angle, the defined limits are between  $360^\circ$  and  $1440^\circ$ ."

### Rotation-resistant wire ropes

According to the regulation of VDI 2358, a wire rope is rotation-resistant, when: "the wire rope, which hardly turns around its longitudinal axis when subjected to unguided load and/or hardly transmits a torque to the attachment at the end in the event of guided rope ends."

According to ISO 21669 and DIN EN 12385-3: "a rope is considered to be rotation resistant if it rotates around its axis at most once at a length of  $1000 \times d$  under a load of 20 % of the minimum breaking force. The rotation can be exhibited here in rope closing or rope opening sense.

For the rotation angle, this implies: between  $-360^\circ$  and  $360^\circ$ " (figure 21).



**Figure 21:** Rotation-resistant rope verotop P: the torques of the rope core and the layer of outer strands, generated under load, work in opposite directions.





### Wire rope lubricant

The wire rope lubricant has two major tasks: it should protect the rope from corrosion and minimize the friction between the rope elements themselves and between the rope and the sheave or the drum.

A reduction of the friction reduces the actuating power and minimizes the wear of the rope, the sheaves and the drums.

We differentiate between wax-based lubricants and oil-based lubricants.

While wax-based lubricants offer a better handling of the ropes, the oil-based lubricants advantage is a better closing of the lubrication film due to the gravitational force of the oil.

The quality of the wire rope lubricant has a great impact on the fatigue resistance of a wire rope (**figure 22**).

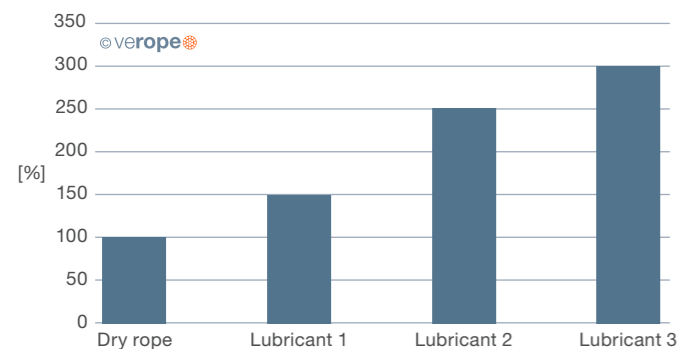

**Figure 22:** Wire rope lubricant impact on the fatigue resistance of the wire rope

### Re-lubrication

Generally wire ropes are lubricated intensively during the production process. Nevertheless, this initial lubrication has to be renewed regularly during the whole rope's lifetime.

A regular re-lubrication contributes to an increase in the rope's service life (**figure 23**).

The lubricant used for re-lubrication needs to be compatible with the lubricant used during production.

It is advised to follow the maintenance instructions in ISO 4309.

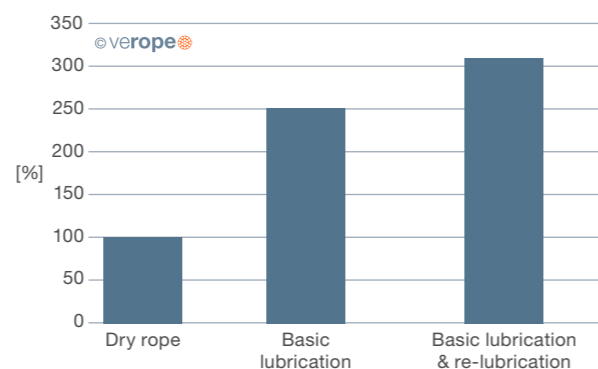

**Figure 23:** Influence of the re-lubrication on the lifetime of a rope



# ROPE CHARACTERISTICS

## 2.1 BREAKING STRENGTH

The calculated breaking strength of a steel wire rope is defined as the metallic cross section of a steel wire rope (the sum of the individual cross sections of all the wires making up the rope) multiplied by the nominal tensile strength of the steel wire rope.

The minimum breaking strength of the steel wire rope is the calculated breaking strength of the rope multiplied by the spin factor. The actual breaking strength of a steel wire rope is the breaking strength of the rope as determined in a breaking test. A new steel wire rope

must achieve an actual breaking strength equal to or higher than the minimum breaking strength.

The breaking strength of a steel wire rope can be increased by increasing the metallic area of the rope (e.g. by using strands with higher fill factors, by compacting the strands or by swaging the rope), by increasing the tensile strengths of the individual wires or by increasing the spin factor of the rope. This can also be achieved by improving the contact conditions between the rope elements by using a plastic infill.

## 2.2 BENDING FATIGUE RESISTANCE

The bending fatigue resistance of steel wire ropes is defined as the number of bending cycles a rope can achieve in a bending fatigue test under defined parameters (e.g. running over sheaves with a defined diameter and a predetermined line pull corresponding to the MBL of the steel wire rope). The bending fatigue resistance of the steel wire rope increases with increasing D/d ratio (= sheave diameter (D): nominal rope diameter (d)) and by reducing the line pull.

The bending fatigue resistance of a steel wire rope can be increased by increasing the contact area between the steel wire rope and the sheave and by increasing the contact conditions between the rope elements, by adding a plastic layer between the IWRC and the outer strands. Due to the larger contact area between the ropes and the sheaves and due to the increased flexibility, 8- strand ropes are more resistant to bending fatigue than 6- strand ropes of a similar design.

## 2.3 FLEXIBILITY

The flexibility of a steel wire rope typically increases with an increasing number of strands and wires in the rope. The flexibility is also influenced by the lay lengths of the strands, of the rope core and the rope as well as by the gaps between wires and strands.

If a rope is not flexible enough, it will have to be forced to bend around a sheave of a given diameter, which will reduce the bending fatigue life of the rope. It will also be forced to bend around a drum of a given diameter. Spooling problems might be a consequence.



## 2.4 EFFICIENCY FACTOR

When running over a sheave, a rope has to be converted from a straight condition into a bent condition at the point when the rope runs onto the sheave and has to be converted again from the bent into the straight condition when it runs off the sheave.

Also the bearing has to be turned. In doing so, the friction forces in the rope as well as the friction forces in the bearing have to be overcome. This leads to a change of the rope force.

One describes the relationship of the rope force on both sides of the sheave as the efficiency factor and accepts that this numerical value also takes into account the friction losses of the bearing. When measuring the efficiency factor of a rope, the loss of the line pull while the rope is running over the sheave is measured.

An efficiency factor of 0,98, or alternatively a strength loss of 2%, is generally assumed for wire ropes.

## 2.5 WEAR RESISTANCE

Changes in line pull will cause changes in the rope length. Rope sections lying on a sheave or on the first wraps of a drum can only adapt to the changing line pull by sliding over the groove surface of the sheave or the drum when the length change occurs. This relative motion will cause abrasion (both in the grooves and on the special wire rope). Using less

and therefore larger outer wires can increase the wear resistance of the rope. The pressure between the sheave and the rope can be minimized due to optimized contact areas; therefore also the wear of the rope can be minimized (**figure 24a**). The wear resistance can also be influenced by the metallurgy of the outer strands.

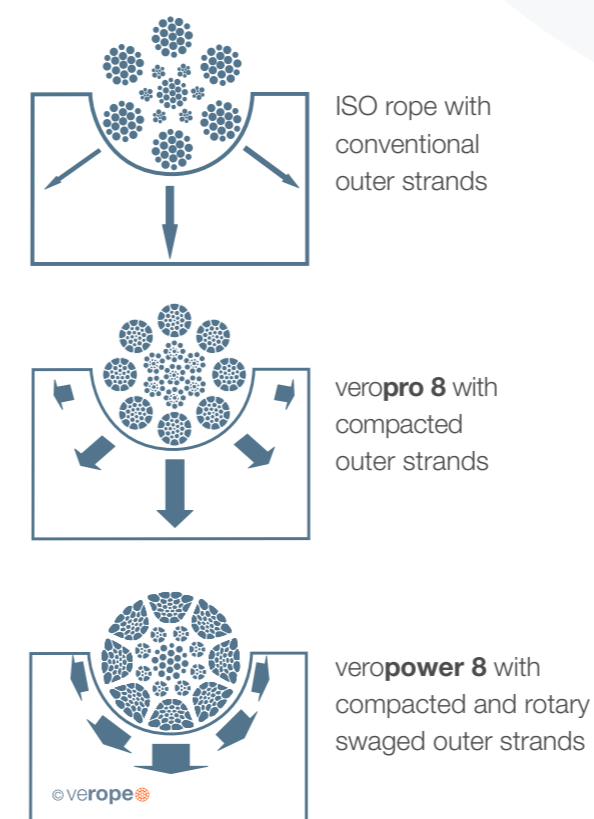

Figure 24a: Comparison wear resistance

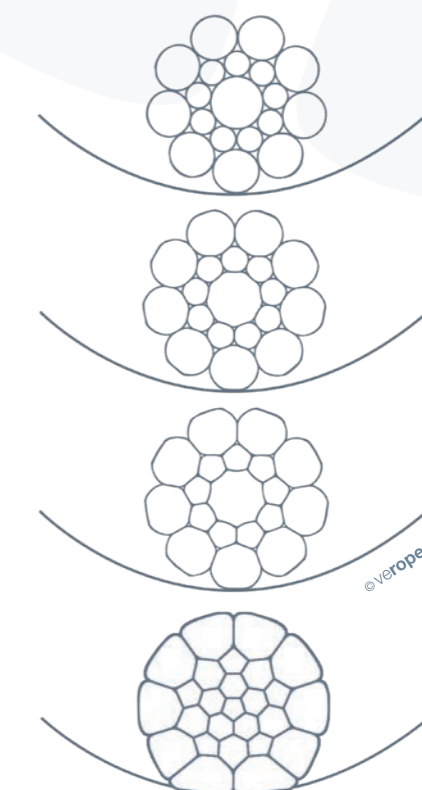

Figure 24b: Contact area of strands



## 2.6 DEFORMATION BEHAVIOR

### Modulus of elasticity

The modulus of elasticity of a material is defined as the proportional factor between load and elongation. The modulus of elasticity is a material property.

Besides the elastic properties of the wire material used, the modulus of elasticity of wire ropes is dependent on the rope geometry and the load history of the rope. Since this is not a material property, ISO 12076 recommends calling this factor the "rope modulus".

**Figure 25** shows a load-elongation diagram of a wire. Here the modulus of elasticity can be determined as the gradient of the curve in the linear area.

**Figure 26** shows a load-elongation diagram of a strand. As the strand consists of several wires of different lengths and different lay lengths or different lay angles, here the shorter and less elastic elements get loaded first. For this reason the curve is not linear in the lower area. The graph only gets linear, when all the wires in the strand bear the load together.

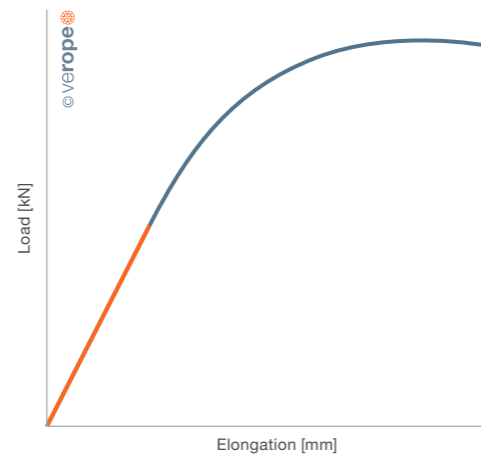

**Figure 25:** Load-elongation diagram of a wire

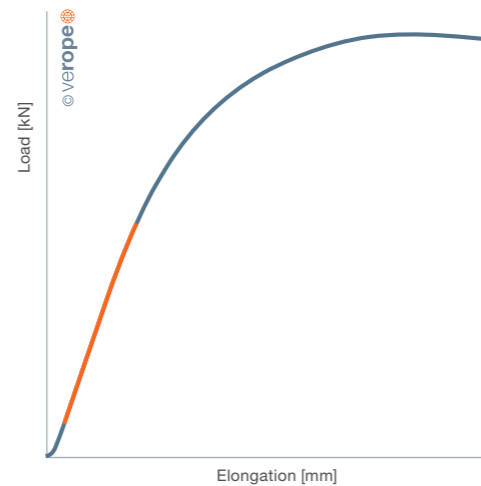
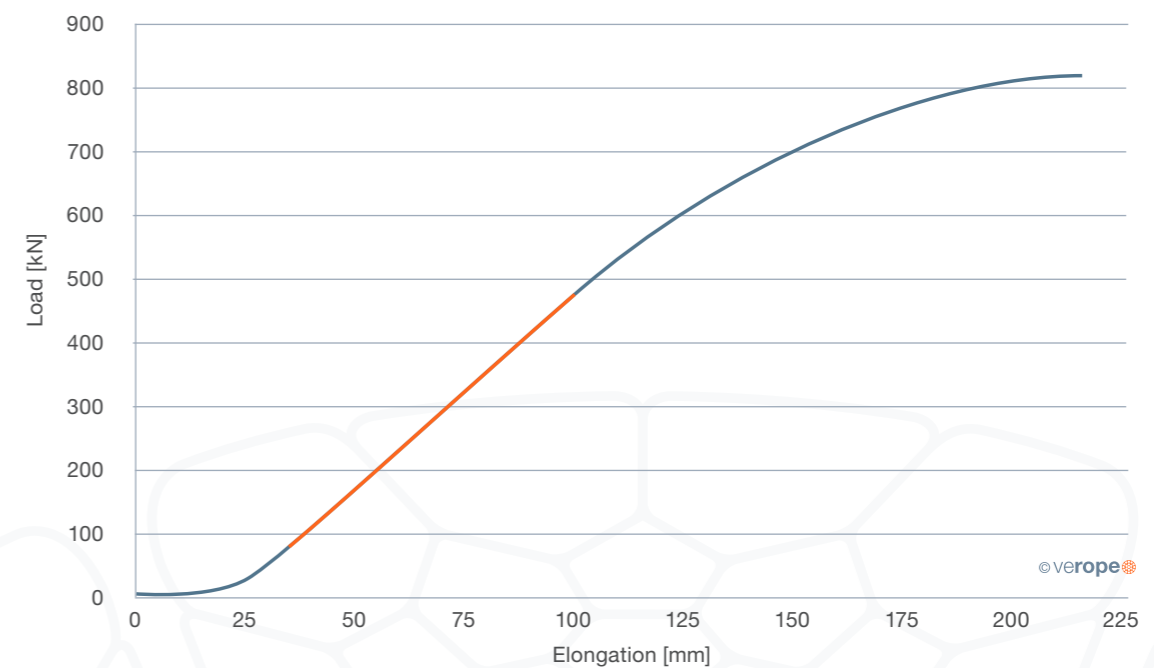

**Figure 26:** Load-elongation diagram of a strand

**Figure 27** shows the load-elongation diagram of a rope. Here you will also find a non-linear correlation in the lower area between load and elongation. Here again the nonlinearity can be explained by the overload of the shorter and the less elastic rope elements. The load-elongation diagram is linear in the area in which all elements share the load and plastically deform. As a consequence of settling effects, the modulus of elasticity

of wire ropes increases over the lifetime. The biggest part of this change happens with the first loading of the rope.

Later the modulus of elasticity varies only very slightly. For this reason a new wire rope should always be loaded and relived multiple times before measuring the modulus of elasticity. The determination of the modulus of elasticity is described in ISO 12076.



**Figure 27:** Load-elongation diagram of a rope



### Radial stability

The radial stability of a rope is a function of the rope geometry and the line pull.

The radial stability of a steel wire rope will typically reduce with an increasing number of rope elements. It will also increase with increasing line pull. Ropes with insufficient radial stability are not suitable for multi-layer spooling.

### Structural stability

It is essential that a rope maintains its structure during its working life.

Adding a plastic layer between the IWRC and the outer strands can increase the stability of the rope structure. The plastic will fix the position of the rope elements relative to each other.

### Diameter reduction of a special wire rope

With increasing line pull, a special wire rope will not only get longer, it will also reduce in diameter.

A great part of that diameter reduction is reversible which means that the rope diameter will increase again after unloading. Part of the diameter reduction, however, is permanent.

If the diameter reduction of a steel wire rope under load is too high, in multi-layer spooling the rope might pull into deeper layers of the drum.

Therefore the diameter reduction of steel wire ropes must be considered when designing ropes for multi-layer applications (**figure 28**).

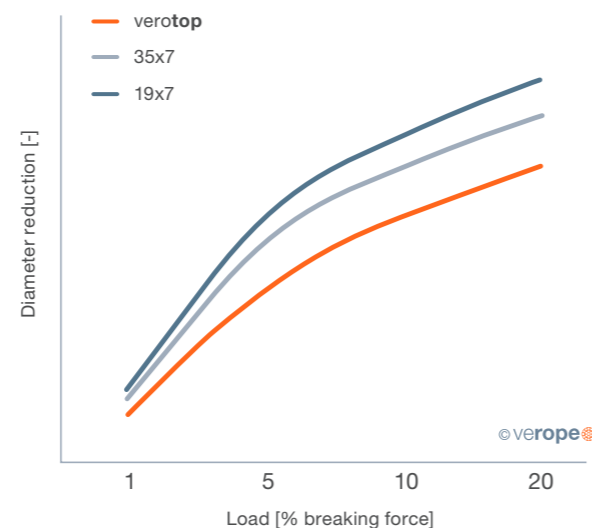

Figure 28: Diameter reduction under load



## WHY SPECIAL WIRE ROPES?

Standard ropes often do not meet the high requirements of many applications of wire ropes. Higher demands for rope lifetime, breaking strengths, rotational stability, flexibility, structural stability and spooling behavior can only be fulfilled by special wire ropes. It is for these reasons that many engineers and end users resort to verope® special wire ropes.

### 3.1 PLASTIC LAYER

Many verope® products have a plastic layer between the steel core and the outer strands.

This intermediate layer enhances the form stability of the rope like a flexible corset and increases the lifetime of a rope especially under difficult working conditions.

The intermediate plastic layer avoids the infiltration of water and dirt, which helps avoiding corrosion in the steel core. This cushion avoids internal steel-to-steel crossover contacts and limit the damage caused by this phenomenon (**figure 29**).

#### The main advantages are:

- Prevention of internal wire breaks
- Preservation of lubricant in the core
- Keeps out infiltration of water, dust, etc. ...
- Reduction of internal stresses
- Improvement of the form stability
- Absorption of dynamic energy
- Reduction of the noise level during operation

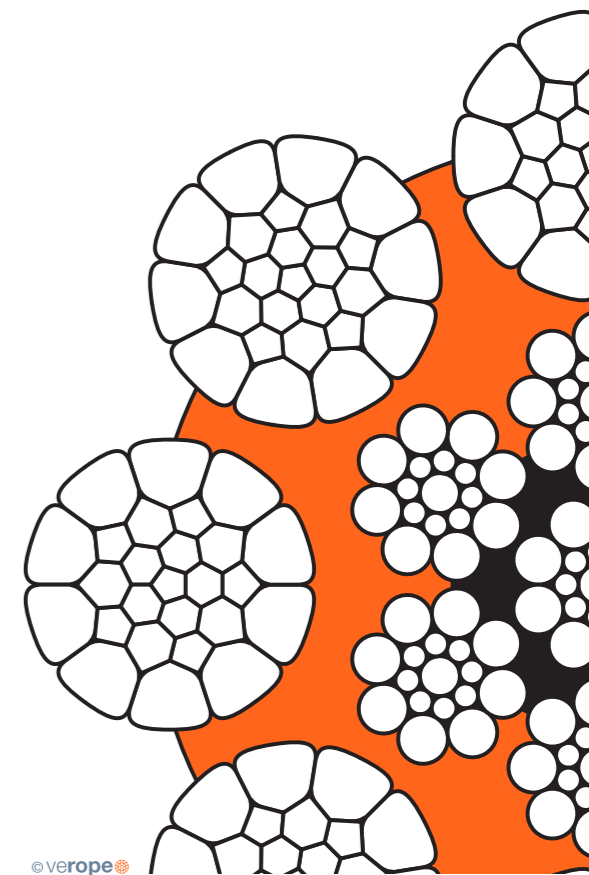

Figure 29: The Plastic Layer (shown in orange)

### 3.2 BREAKING STRENGTH

verope® Special Wire Ropes are designed to achieve high breaking loads and better strength to weight ratios.

High ductility wires drawn to controlled tolerances are stranded and closed into a rope constructed with optimized gap spacing between the individual rope elements. verope® products achieve an increased fill factor by using compacted strands as well as rotary swaging in their method of rope construction. Parallel lay elements in the rope composition increase the metallic cross section.

Crane designers use the technical advantages, that are provided by the rope manufacturers to reduce the drum and sheave dimensions in line with maintaining the recommended D/d ratios. The material cost and weight saving effect on the static design of the crane elements is substantial.

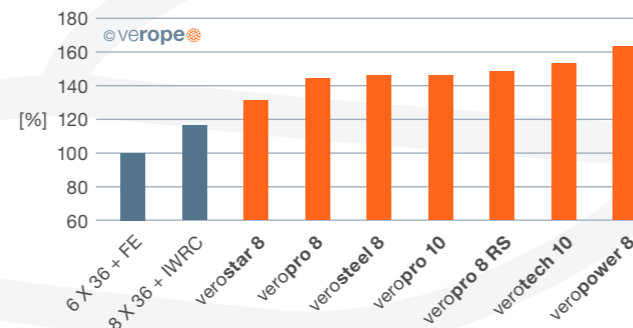

**Figure 30:** Breaking strengths of non-rotation resistant ropes

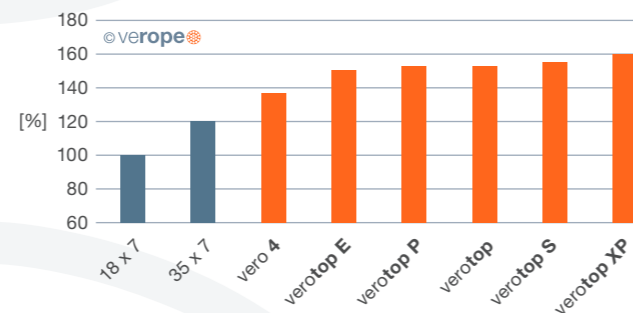

**Figure 31:** Breaking strengths of rotation-resistant ropes

#### Breaking strengths and Swivel

The minimum breaking strength given in catalogues is valid for wire ropes whose ends are protected against twisting. The breaking strengths of non-rotation resistant ropes are reduced significantly by the usage of a swivel. Even if the rope would not immediately break under the nominal load, several now overloaded elements of the rope will become disproportionally loaded. Also structural changes, like basket deformation could appear very fast. Therefore, non-rotation resistant ropes should not be used with a swivel.

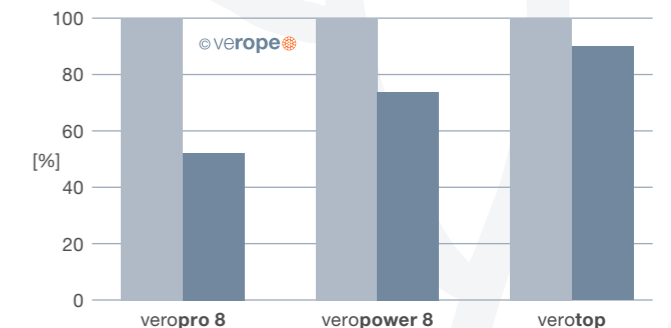

**Figure 32:** Breaking strengths of a rope without and with using a swivel

### 3.3 BENDING FATIGUE AND ROPE LIFETIME

verope® operates the first two bending fatigue machines world-wide built according to a revolutionary concept.

The steel wire rope is installed in the test machine, put under tension, and then the rope travels back and forth over five test sheaves until it finally breaks in the middle. Due to the tilt of two of the sheaves, there is no angle of deflection in the system.

Only then the rope analysis starts: To the left and to the right of the broken section, which during the test has

travelled back and forth over five sheaves, the machine has rope sections which only travel over four sheaves and don't make it to the fifth. Regardless of what the number of cycles to failure will be, these sections will always have made 80% of this number.

These sections, and the further sections which will have travelled over 3, 2, 1 and 0 sheaves only and which will represent the condition of the rope after 60%, 40%, 20% and 0% of the rope life are cut out for analysis (figure 35).

One of the two sections of each condition is used to determine the number of external wire breaks and the changes in rope diameter and lay length. Then the section is taken apart in order to also determine the number of internal wire breaks on the underside of the outer strands, on the outside and inside of the IWRC and on individual strands as well as changes in the IWRC and strand diameters and lay lengths.

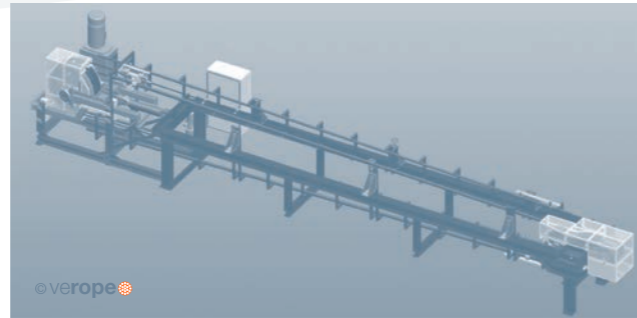

Figure 33: Bending fatigue Machine

This way, the sections will tell you how the external wire breaks develop over the lifetime of the rope, how the internal wire breaks develop over time, how the plastic infill looks at different stages of the rope life and which elements start to deteriorate first. These results can help verope® to improve the product design of a new rope after only a single test.

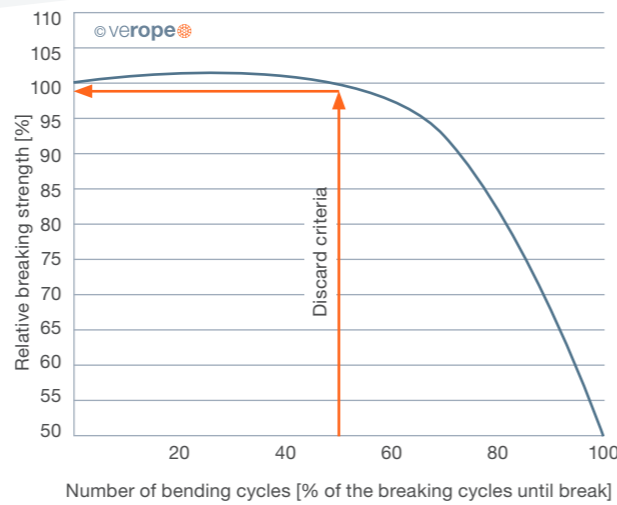

Figure 34: Rope breaking strength in % of the breaking strengths of a new rope dependent on the lifetime until break. A steel wire rope should have a breaking strength as high or higher than new until it reaches the discard number of wire breaks.

The comparable 80%, 60%, 40%, 20% and 0% sections on the other side of the break are subjected to pull tests to destruction.

This way verope® can determine how the strength of this rope design, its modulus of elasticity and its elongation at break develops over the lifetime of the rope. A steel wire rope should have a breaking strength as high or higher than new until it reaches the discard number of wire breaks (figure 34).

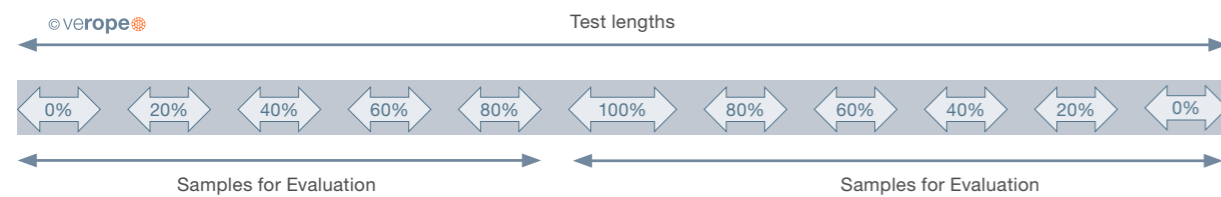

Figure 35: Sampling for analysis



Figure 36: Condition at 0% of the bending cycle until breaking point



Figure 37: Condition at 20% of the bending cycle until breaking point



Figure 38: Condition at 40% of the bending cycle until breaking point



Figure 39: Condition at 60% of the bending cycle until breaking point



Figure 40: Condition at 80% of the bending cycle until breaking point



Figure 41: Condition at 100% of the bending cycle until breaking point

Due to the detailed analysis of the several working sections, the development of external wire breaks over the lifetime can be evaluated very precisely (figure 42).

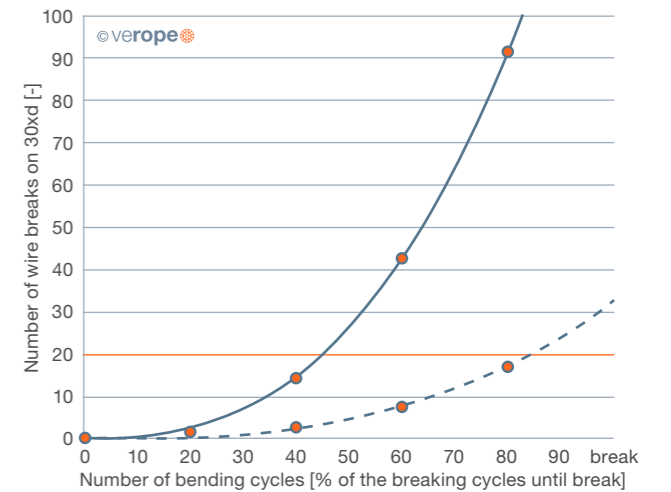

Figure 42: Number of visible (pulled trough line) and invisible wire breaks (sketched line) dependent on the rope lifetime. After the end of the bending fatigue test, the analysis of the rope sections with the different fatigue numbers show the marked numbers of wire breaks.



By disassembling the rope pieces, the internal wire breaks depending on the lifetime can be evaluated (figure 43).

The veropro 8 construction (like many other non-rotation resistant ropes) shows a higher number of visible wire breaks than internal (invisible) wire breaks.

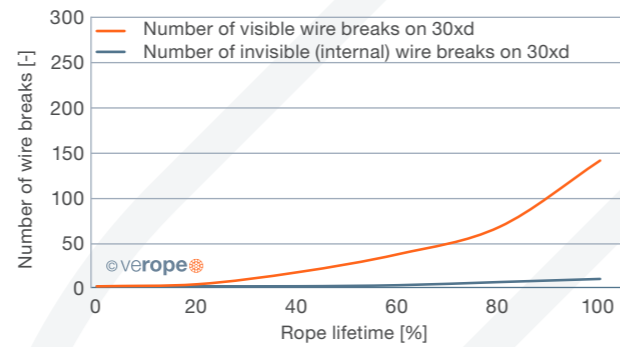

Figure 43: Development of the visible wire breaks on the wire rope surface and the wire breaks inside the rope that are visible from outside

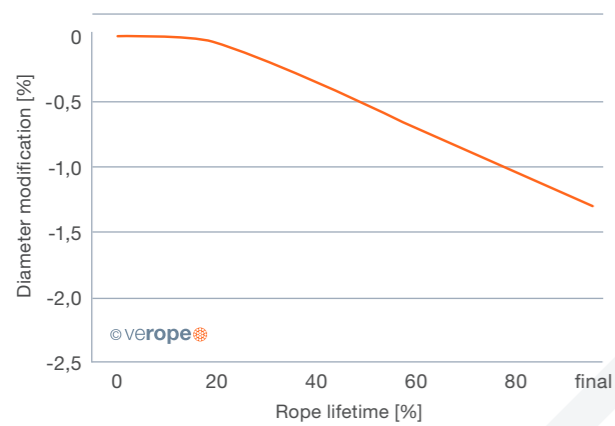

Figure 44: Diameter modification of the rope in the bending fatigue test

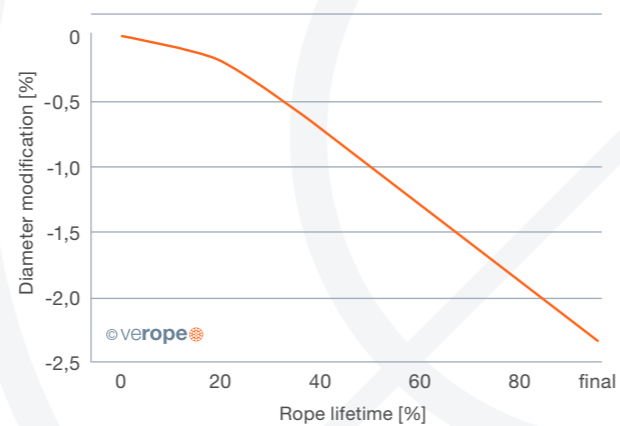

Figure 45: Diameter modification of the steel rope core in the bending fatigue test

Bending fatigue tests are taken normally until the break of the rope or a strand. The exact point of discard can be determined by evaluating the single rope sections. This results in the so called "rest-lifetime" (lifetime between discard and break) (figure 46).

Figure 47 shows a comparison of the numbers of bending cycles until discard (according to ISO 4309) and until break of non-rotation resistant ropes under the same test conditions.

Figure 48 shows a comparison of the numbers of bending cycles until discard (according to ISO 4309) and until break of rotation-resistant ropes under the same test conditions.

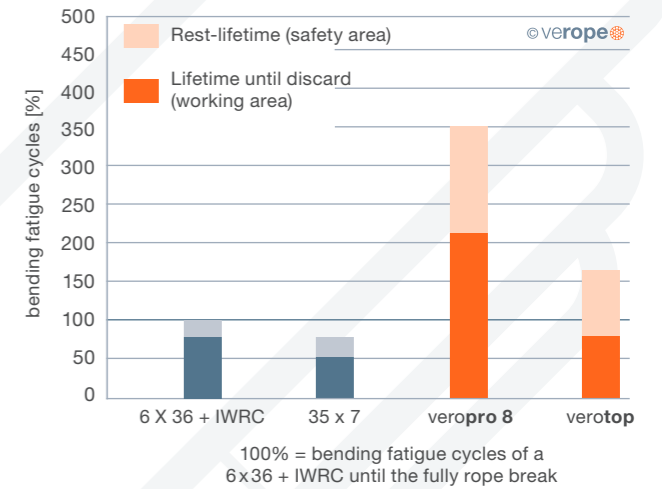

Figure 46: Number of bending cycles until discard and until break

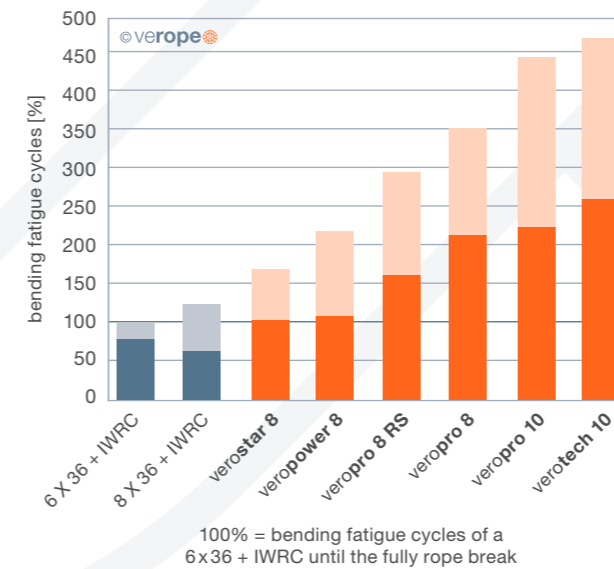

Figure 47: Number of bending cycles until discard and until break (non-rotation resistant ropes, equal load)

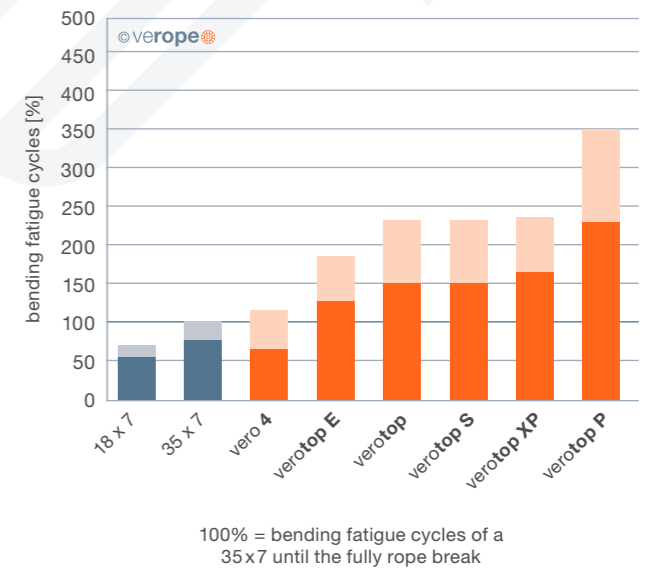
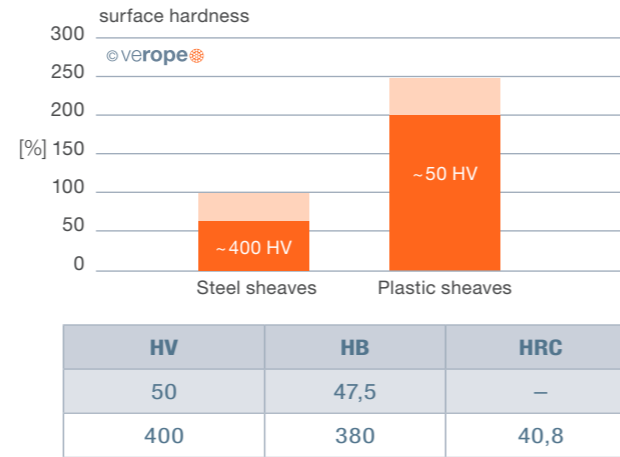

Figure 48: Number of bending cycles until discard and until break (rotation-resistant ropes, equal load)



**Bending fatigue when using steel or plastic sheaves**

The lifetime of a rope is significantly influenced by the sheave material. By the use of plastic sheaves, the bending fatigue rises clearly in comparison to the use of steel sheaves. The remaining "rest-lifetime" of the rope after the achievement of the discard criteria until the break of the rope is with regard to the bending cycles more or less the same, nevertheless it drops significantly in percentage. Therefore the rope inspection must be carried out especially carefully when using plastic sheaves. verope® recommends plastic sheaves, hence, only in applications where the ropes are checked magnet-inductively or where the rope gets damaged primarily outside like in multi-layer spooling (figure 49).



HV = Hardness Vickers HB = Hardness Brinell HRC = Hardness Rockwell

**Figure 49:** Influence of the sheave material onto the rope lifetime and conversion of the various hardness units

**Bending fatigue of ungalvanized and galvanized ropes**

A comparison of the bending fatigue of ungalvanized and galvanized ropes until the achievement of the discard criteria according to ISO 4309 and until break of the rope shows, that galvanized ropes usually reach more bending cycles. The zinc coating offers better "emergency operating features" when the rope is not lubricated any more and protects the rope from mechanical wear and the resulting corrosion (figure 50).

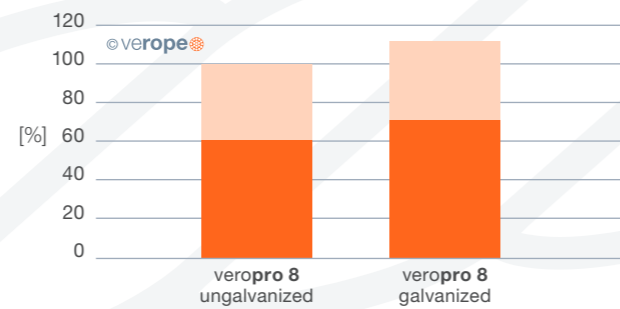
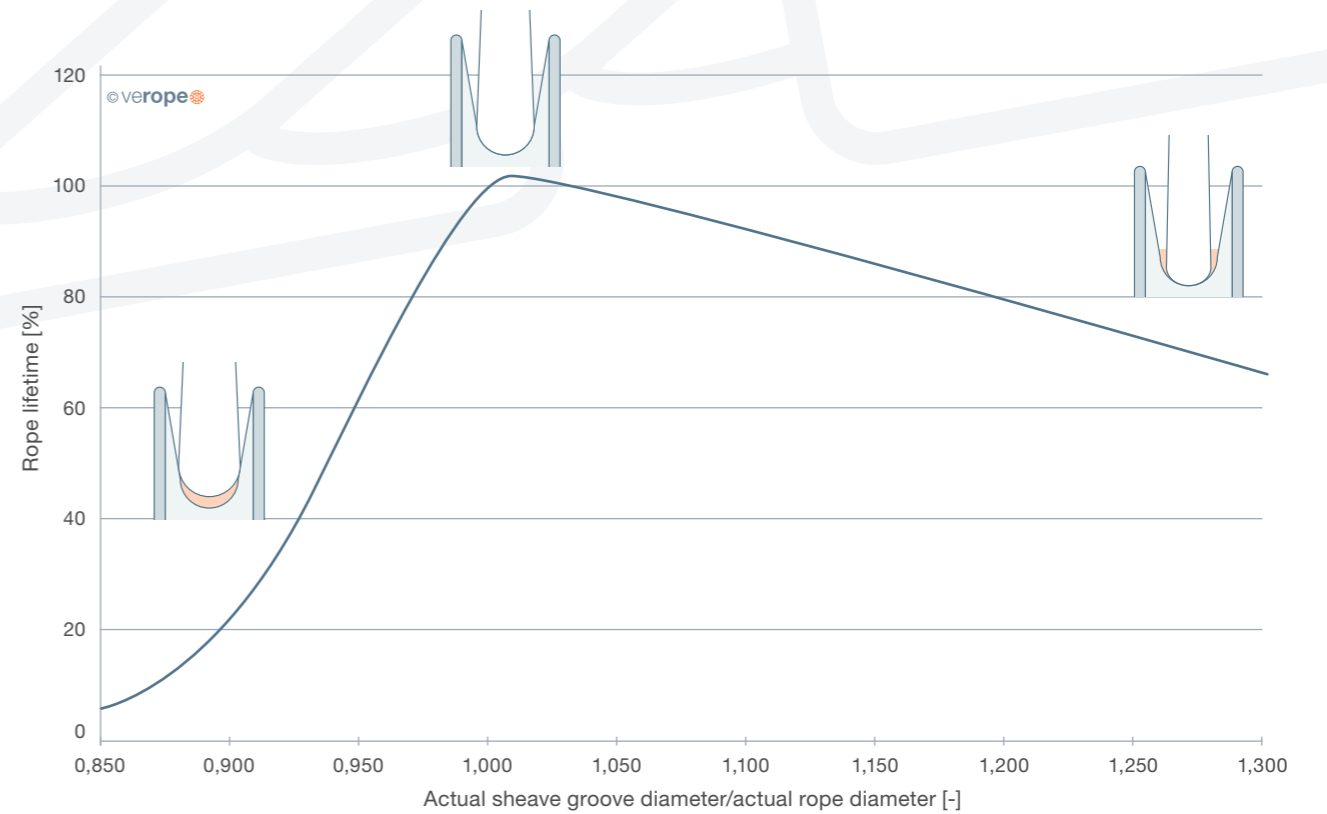

**Figure 50:** Comparison of bending fatigue of ungalvanized and galvanized ropes

**Bending fatigue in dependence on the groove diameter**

According to ISO 16625 the groove of a sheave should have a diameter, that is 5% to 10% bigger than the rope diameter. During the operating time, the rope diameter will decrease. With this decreased diameter the rope will dig itself into the sheave groove and will reduce the groove diameter. Therefore, with the installation of the rope it should be considered, that the groove diameter of the sheave is at least 1% bigger than the measured rope diameter.

A sheave with a too big groove diameter cannot support the rope well and leads to increased surface pressure (between sheave and rope). Consequently the lifetime of the rope decreases steadily with an increasing groove diameter. If the groove diameter is too small, the rope will be squeezed and the lifetime drops extremely.



**Figure 51:** Influence of the groove diameter onto the rope lifetime (see also page 60)





#### Bending fatigue in dependence of the line pull

The appearing line pull has a considerable impact on the bending fatigue.

While for example 950 000 bending cycles can be reached with a line pull of 2t, only 290 000 bending cycles are reached with a linepull of 4t (**figure 52**).

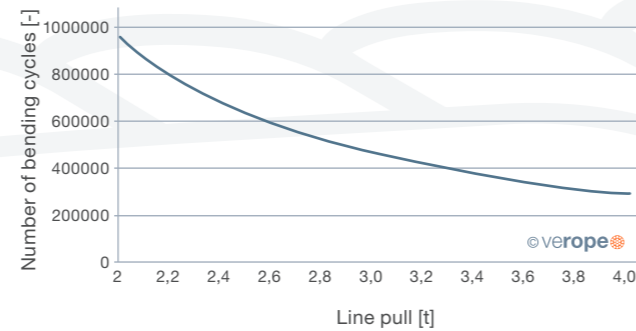
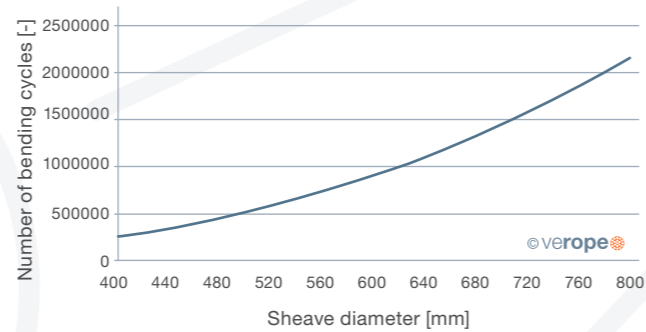

**Figure 52:**

Influence of the line pull onto the rope lifetime

#### Bending fatigue in dependence of the sheave diameter

The applied diameters of the sheave, as well as the diameters of the drums have a huge impact on the lifetime of a rope. In the shown example, a rope running over a sheave with a diameter of 800mm reaches more than 2.000.000 bending cycles, the bending condition reduces by reducing the diameter of the sheave to 400mm to 290.000 bending cycles (**figure 53**).



**Figure 53:**

Influence of the sheave diameter onto the rope lifetime

## 3.4 DEFORMATION BEHAVIOR

In many applications the exact knowledge of the deformation behavior of wire ropes is of great importance.

verope® has investigated in many work-intensive tests the modulus of elasticity (lengthwise and transverse), the elastic and plastic deformation as well as the diameter reduction of its products. Many technical parameters of the rope can be determined by the creation of a load-elongation diagram (**figure 54**).

verope® loads and relieves the ropes in steps and determines the elongation under load as well as the remaining elongation after discharge. The modulus of elasticity is determined from the gradient of the linear area of the load curves. At the same time the diameter reduction in dependence of the load is measured. In order to be able to determine also the breaking strength and the elongation at break, the ropes are loaded up to break.

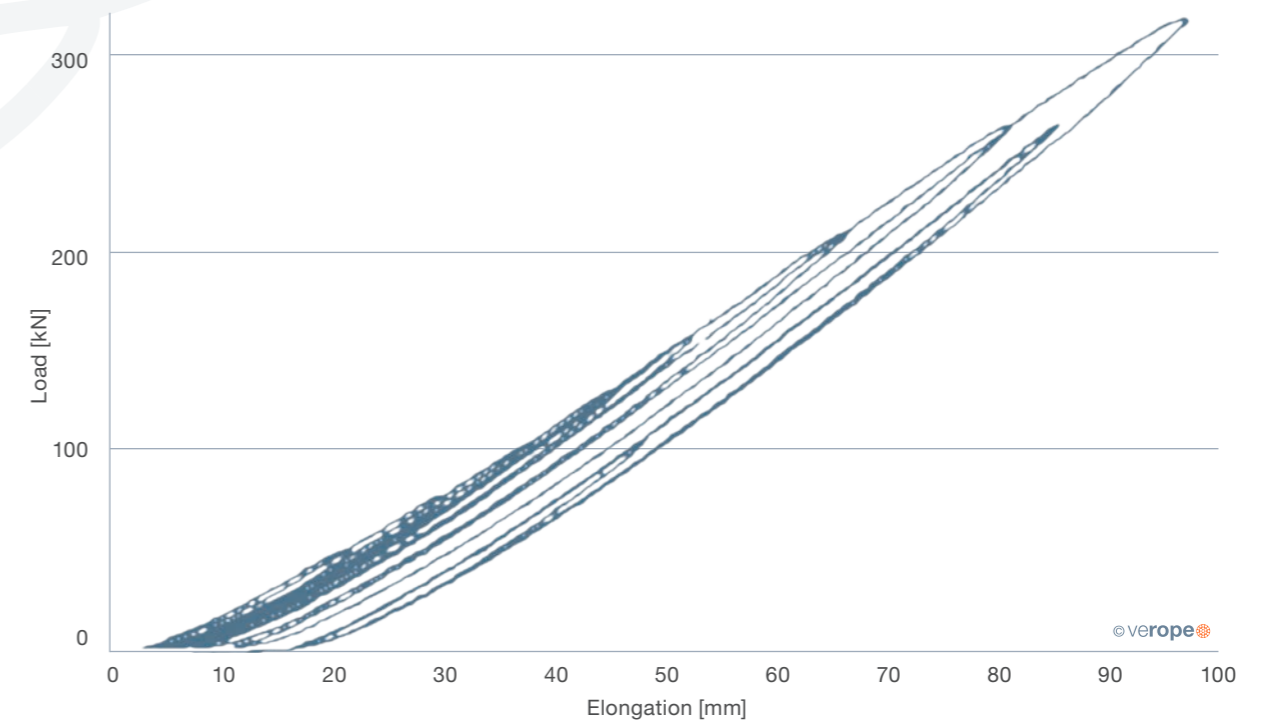
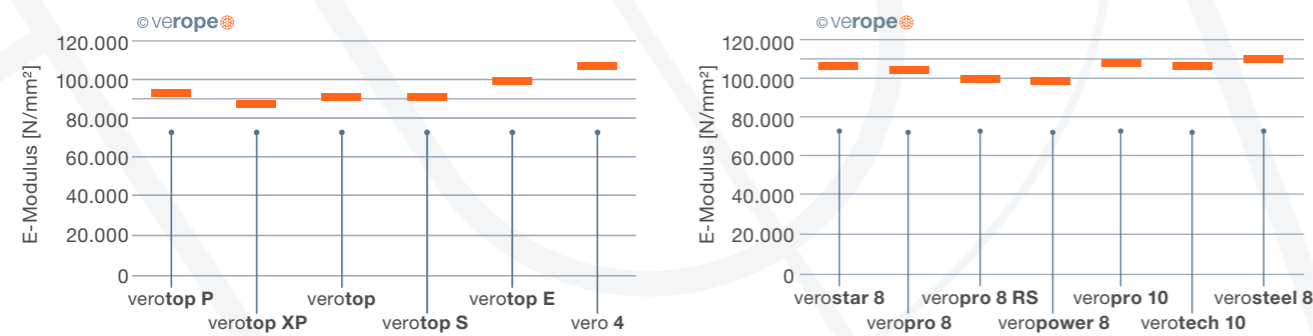

**Figure 54:** Load-elongation diagram of a verope® special wire rope for determining the modulus of elasticity



**Modulus of elasticity**

Within a rope construction, the modulus of elasticity varies slightly in dependence of the rope diameter, the lay type (lang's lay or regular lay) and of the tensile strength of the wire (**figure 55**). As a rule, the modulus of elasticity of wire ropes increases over the lifetime of the rope.

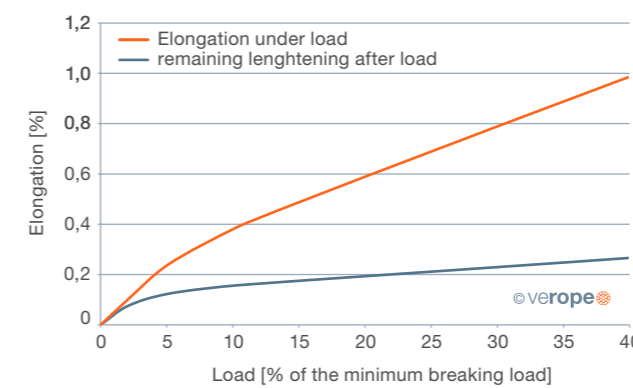

**Figure 55:** E-Modulus rotation resistant ropes

**Elongation**

In particular with suspension ropes, but also with running ropes an exact knowledge of the elongation of the rope under load and the remaining rope lengthening after load is important. verope® has measured these relevant values for all its products with high precision on long test lengths. Below you can find measured values

of typical verope® rope constructions. We are pleased to provide you with the results of other verope® rope construction for your interpretation.



**Figure 56:** Elongation under load (upper graph) and remaining lengthening after load (lower graph) depending on the line pull (veropro 8, ordinary lay, 1960 N/mm<sup>2</sup>)

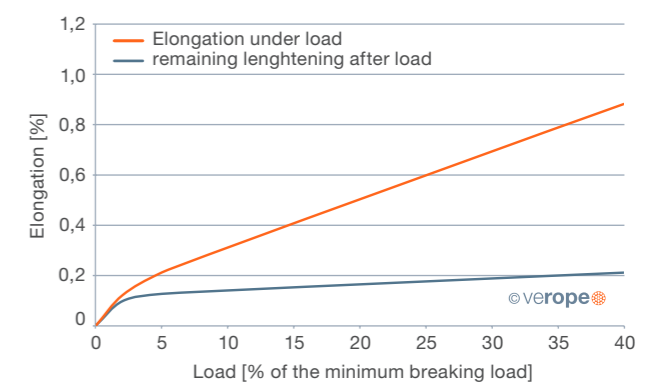

**Figure 57:** Elongation under load (upper graph) and remaining lengthening after load (lower graph) depending on the line pull (verotop P, regular lay, 1960 N/mm<sup>2</sup>)

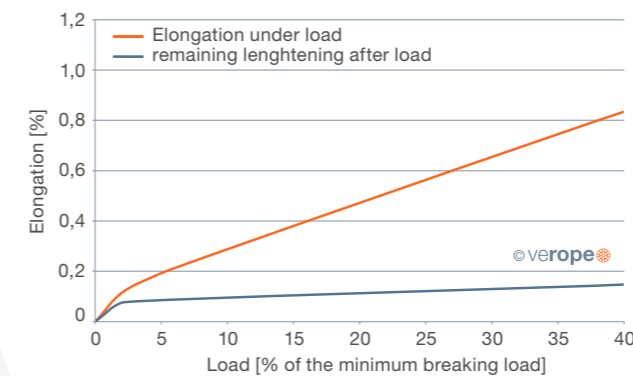

**Figure 58:** Elongation under load (upper graph) and remaining lengthening after load (lower graph) depending on the line pull (verotop, regular lay, 1960 N/mm<sup>2</sup>)



**Diameter reduction**

A rope becomes longer and thinner under load. The diameter reduction can influence the rope behavior in multi-layer spooling strongly. verope® has measured the diameter reduction of all its products and is pleased to provide you with the measured values if required.

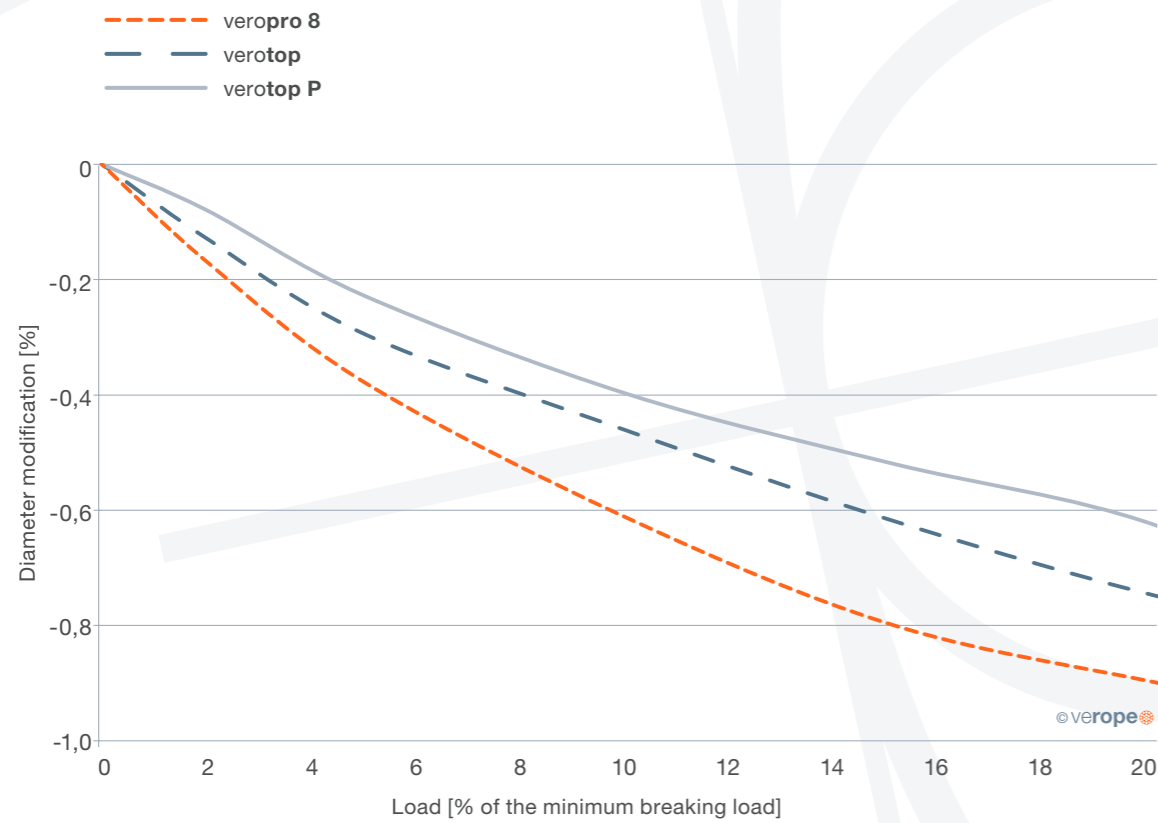

Figure 59: Diameter modification depending on the line pull

**Lateral stability with and without load**

In multi-layer spooling, wire ropes are not only exposed to tensile and bending loads, but also to enormous transverse loads. In order to be able to withstand these loads and to avoid spooling problems, a high degree of radial stability is necessary. The radial stability of the rope also influences the deformation behavior of

the drum. That's why it is important for the designer of the drum to know the radial stability in the form of the transverse modulus of elasticity of the ropes. Radial stability is defined as the resistance of a wire rope against transverse (radial) deformation (Ovalization). verope® measures the radial stability of its products with (figure 62) and without load (figure 60 & 61).

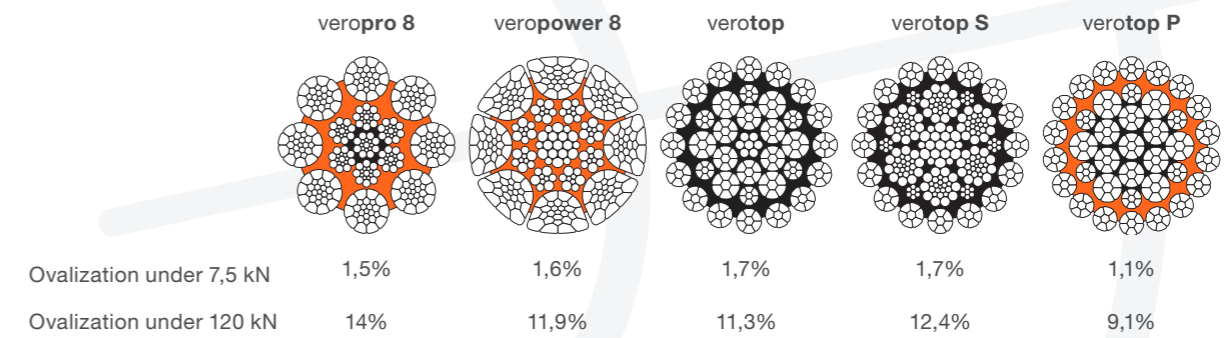

Figure 60: Measurement without load

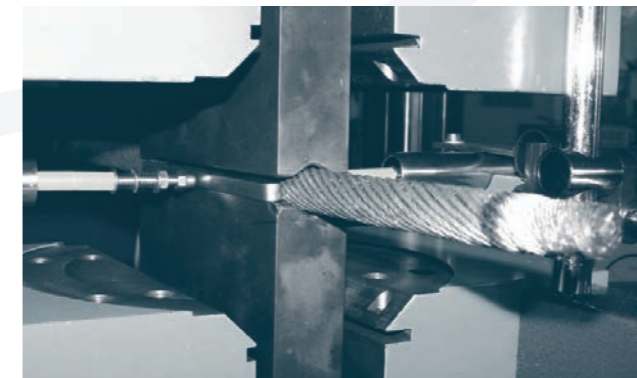
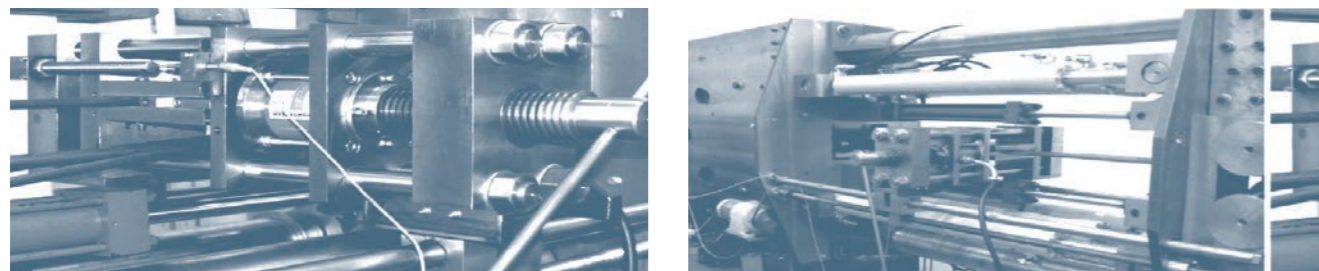
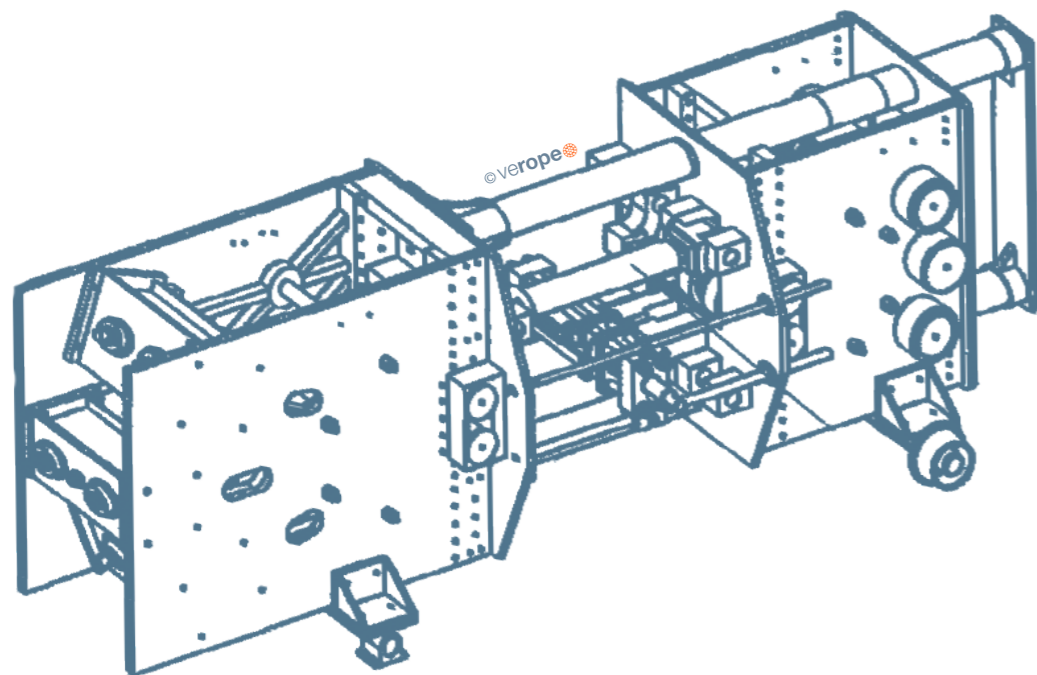

Figure 61: Testing device (source: TU Dresden)

**Measurement under load**

At the determination of the lateral modulus of elasticity under load, the deformation behavior of the rope is measured under various tensile loads and different transverse loads (figure 62).

verope® has determined the lateral modulus of elasticity for all its products and is pleased to provide them to designers when required.

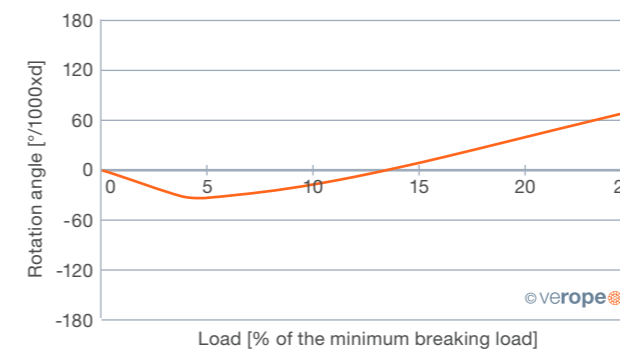

**Figure 62:** Testing principle of the measurement of the modulus of elasticity under load (source: TU Clausthal)

**3.5 ROTATIONAL BEHAVIOR**

To evaluate the rotational behavior of a wire rope, the rope torque and the rotation angle are measured. For the measurement of the rotation angle a smooth swivel is fastened at the end of the rope. During the test the twist of the rope is measured in dependence of the load.

The twist usually is given in degree per 1000 x rope diameter. To measure the rope torque both rope ends are protected against twisting. At one end of the rope the rope torque in dependence of the load is measured, with which the rope wants to twist the end connection.



**Figure 63:** Typical rotation angle test of the rope construction verotop

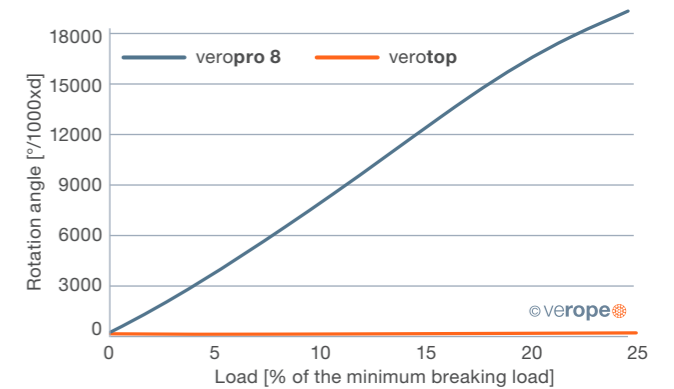

**Figure 64:** Rotation angle test veropro 8 and verotop

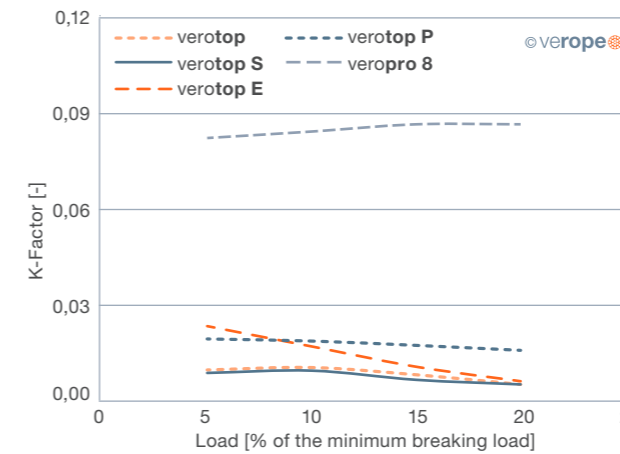

**Figure 65:** Torque of different verope® ropes

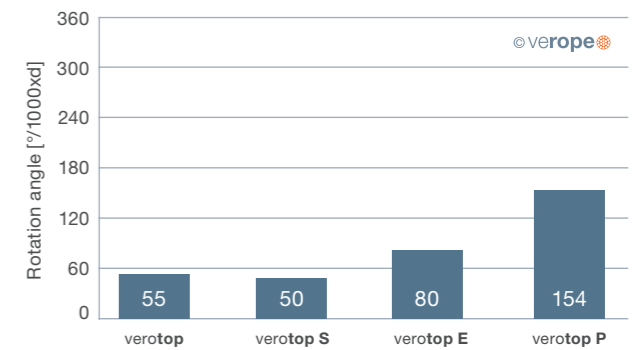

**Figure 66:** Rotation angle under load of 20% of the minimum breaking load

### 3.6 FLEXIBILITY

The flexibility of a rope is a measure of how easily a rope allows itself to bend around a given diameter. The flexibility of a rope is among other things dependent on the line pull. The flexibility of an *unloaded* rope can be measured by the sag of a rope under its own weight. **Figure 67** shows the maximum slack of the rope for different free rope lengths (expressed as a multiple of the rope diameter). The flexibility of ropes *under load* is measured as the efficiency factor of the rope while running over a sheave.

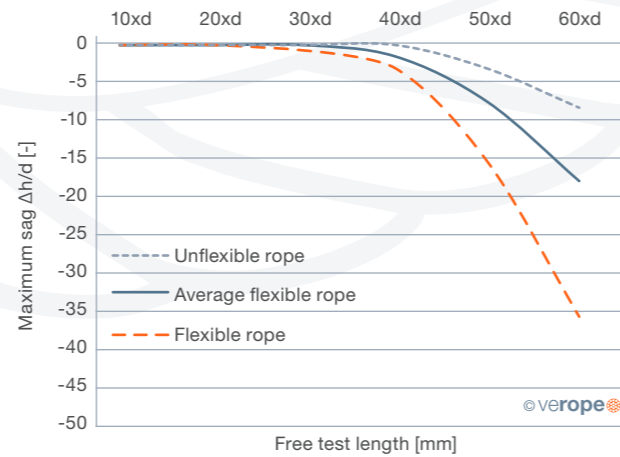

**Figure 67:** Sag of rope  $\Delta h/d$  of different ropes depending on the free rope length as a degree for flexibility. More flexible ropes show a bigger sag.

### 3.7 EFFICIENCY FACTOR

**Figure 68** shows a typical diagram of a rope efficiency factor under line pull. In many specified standards one finds the reference, that for dimensioning a reeving system using roller bearings it should be calculated with an efficiency factor of 0.98, this value is marked in **figure 68**. However, the designer of a reeving system needs the efficiency factor under high line pulls (area B in the diagram, here the efficiency factor is higher than 0.98) for the calculation of the required drive power. In order to calculate the minimum weight of the unloaded bottom hook block the designer needs the efficiency factor under relatively low line pulls (area A in the diagram, here the efficiency factor is clearly lower than 0.98). To help the designer in his interpretation, verope® measures the efficiency factor of its products in the low-load range and in the range of high loads with high accuracy (**figure 69 & 70**).

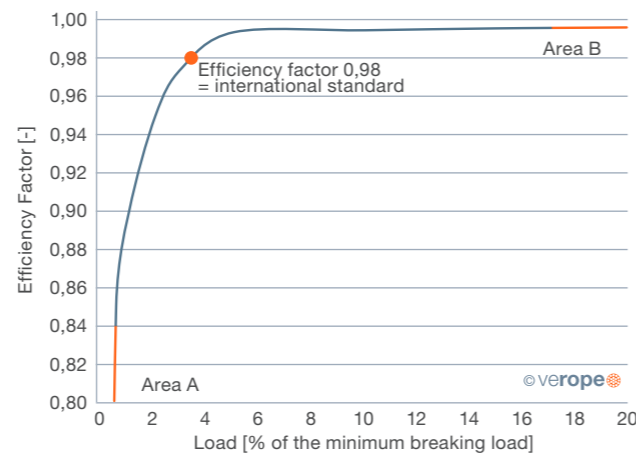
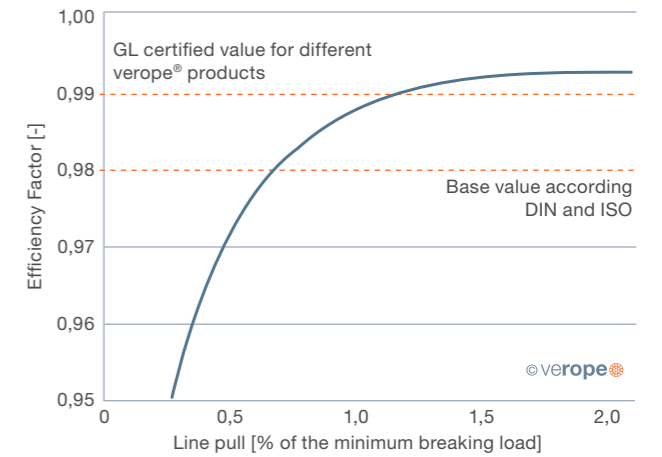

**Figure 68:** Efficiency factor depending on the line pull

As the very first special wire rope manufacturer, verope® has measured the efficiency factor of its products over the lifetime of the ropes. Typically the efficiency factor of the rope improves first over the lifetime and drops later to reach the initial value at discard. **Figure 71** shows a typical example.

Under higher loads, the efficiency factor of verope® special wire ropes with a D/d ratio of 20 or higher lies demonstrably above 0.99. Therefore shall for example cranes, that are certified by Germanischer Lloyd using various verope® special wire ropes, be interpreted with an efficiency factor of 0.99.

**Please contact us for further details.**



**Figure 69:** Efficiency factor measurement over the low load range until 2% of the minimum breaking load

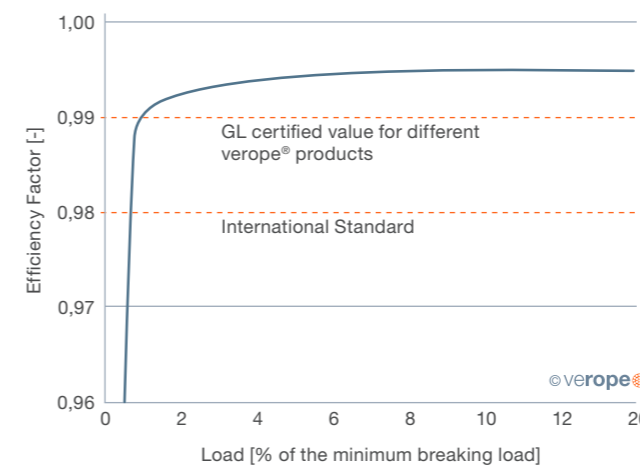

**Figure 70:** Efficiency factor measurement over the load range until 20% of the minimum breaking load

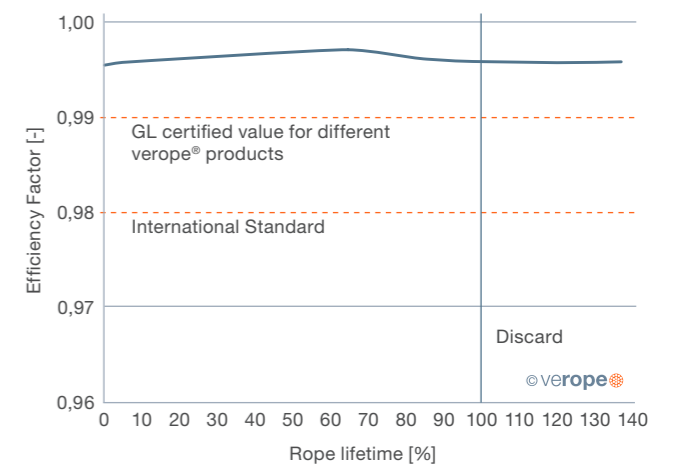

**Figure 71:** Efficiency factor measurement over the rope lifetime under load



# DISCARD CRITERIA (ISO 4309)

**Correct evaluation of our verope® special wire ropes for determining the replacement state, based on visible wire breaks according to ISO 4309.**

The International Standard ISO 4309 - "Cranes – Wire ropes - Care and maintenance, inspection and discard", 4th edition 08/2010 - provides comprehensive information. A frequent discard criterion, among many others discussed in detail by the standard, is the number of visible broken wires. Depending on the rope construction, categorized by the Rope Category Number RCN acc. to standard's annex G, the relevant crane classification M1 to M8 and given system such as a single- or multi-layer drum, the discard criteria can be determined by the number of visible broken wires. This means besides the rope construction it is also the relevant machine used, its design and classification

that determines the discard criteria. Therefore, it is no longer possible to give a general number of visible broken wires for a given rope construction, signaling discard. To give you the correct allocation of your verope® special wire rope to this International Standard ISO 4309, please find below the respective classification of the "Rope Category Number RCN". Please note that within a rope construction its RCN-number may change depending on rope's nominal diameter.

With this information, you can now determine in compliance with the actual type of your application the number of visible broken wires, signaling discard of the rope.

**If you have any further questions regarding discard, please don't hesitate to contact us. We are happy to assist you!**

## ROTATION-RESISTANT SPECIAL WIRE ROPES

verope® special wire rope construction	Number of outer strands	Number of load-bearing wires in the outer strands	Rope category RCN according to ISO 4309	Stripping wire breaking number according to ISO 4309 <sup>1</sup>			
				For applicable rope ranges see footnote <sup>2</sup>		For applicable rope ranges see footnotes <sup>3,4</sup>	
				over a length of		over a length of	
				6 x d <sup>5</sup>	30 x d <sup>5</sup>	6 x d <sup>5</sup>	30 x d <sup>5</sup>
vero 4	4	144	22	2	4	4	8
verotop XP	16	96	23-1	2	4	4	8
verotop verotop S verotop S+ verotop E	16	112	23-2	3	5	5	10
verotop P	18	126	23-3	3	5	6	11

Tables do not apply to special rope constructions. Please contact verope® directly for rope constructions that are not included.

## NON-ROTATION RESISTANT SPECIAL WIRE ROPES

verope® special wire rope construction	Nominal rope diameter d (mm) <sup>7</sup>	Number of outer strands	Number of load-bearing wires in the outer strands	Rope category RCN according to ISO 4309	Stripping wire breaking number according to ISO 4309 <sup>1</sup>					
					For applicable rope ranges see footnote <sup>2</sup>			For applicable rope ranges see footnotes <sup>3,4</sup>		
					Classes M1 to M4 or class unknown <sup>6</sup>			All classes M1 to M8		
					Cross stroke		Equal stroke		Cross and equal stroke	
					over a length of			over a length of		
6 x d <sup>5</sup>	30 x d <sup>5</sup>	6 x d <sup>5</sup>	30 x d <sup>5</sup>	6 x d <sup>5</sup>	30 x d <sup>5</sup>					
verostar 8 veropro 8 veropro 8 RS verosteel 8	6 to 7	8	136	3	4	8	2	4	8	16
	8 to 42	8	208	9	9	18	4	9	18	36
	43 to 48	8	248	11	10	21	5	10	20	42
	larger 48	8	288	13	12	24	6	12	24	48
veropower 8	up to 40	8	208	9	9	18	4	9	18	36
	41 to 46	8	248	11	10	21	5	10	20	42
	larger 46	8	288	13	12	24	6	12	24	48
verotech 10 veropro 10	larger 10	10	260	11	10	21	5	10	20	42
veropro 10	larger 49	10	310	-	12	24	6	12	24	49
verotech 10	6 to 9,5	9	153	4	5	10	2	5	10	20
	10 to 16	9	234	10	10	19	5	10	20	38

**Note: 1)** Please note that a counted broken wire always has two ends. **2)** Shall be applied exclusively to those sections of rope running only over steel sheaves and/or spooling on a single-layer drum. For single layer spooling ordinary lay ropes have to be used. The wire breaks are randomly distributed. **3)** Shall be applied exclusively to those sections of rope spooling on a multi-layer drum. **4)** The values are valid only in conjunction with footnote 3 and apply to deterioration that occurs at the cross-over zones and interference between wraps due to fleet angle effects. Note: These values do not apply to those sections of rope running only over sheaves but do not spool on the multi-layer drum! **5)** d = nominal rope diameter **6)** Twice the number of broken wires listed may be applied to ropes on mechanisms whose classification is known to be M5 to M8. **7)** Other rope diameters on request.

# CRANE COMPONENTS

## 5.1 DRUMS

Drums are used to pull in and store steel wire ropes. The rope can be spooled in single-layer or in multi-layer spooling.

Single-layer drums can be ungrooved or have a helical groove. The pitch of the drum will typically be nominal rope diameter +10 %.

Multi-layer drums can be helical or have a Lebus®-type groove. While helical-type grooves have a constant pitch of the drum, the Lebus®-type grooves show on 1/3 of the circumference of the drum a pitch of 0° (means they are parallel to the flange), followed by drum grooves which are inclined by 3° on about 1/6 of the circumference of the drum. The Lebus®-type grooves typically have a pitch of about nominal rope diameter plus 4% or to plus 5 %.

The flexibility and the radial stability of a steel wire rope and the D/d ratio of the drum are important influences for the quality of the spooling behaviour.

In order to avoid twisting of the wire rope by the drum, the drum rule should be obeyed. A right hand drum should be operated with a left hand lay rope, a left hand drum should be operated with a right hand lay rope.

In multi-layer drums, the direction of the drum changes with every layer. Here the lay direction of the steel wire rope should either be chosen to suit the direction of the reeving (a left hand reeving should have a right hand rope and a right hand reeving should have a left hand rope) or the lay direction of the steel wire rope should be chosen for the most used layer of the drum (see also page 52 & 53).

## 5.2 SHEAVES

Sheaves are used to change the direction of a steel wire rope. When entering a sheave, a steel wire rope will be bent and subjected to half a bending cycle. When leaving the sheave on the other side, the rope section will be straightened and thereby be subjected to another half a bending cycle. The diameter of a sheave is often measured as a multiple of a rope diameter, the D/d ratio. A D/d ratio of 20 means, that the sheave diameter (measured from center rope to

center rope, see **figure 73**) is 20 times the nominal rope diameter. The tread diameter here is  $19 \times d$ .

The fatigue life of a steel wire rope will increase with increasing D/d ratio (see **figure 53**, page 32).

According to ISO 16625, groove opening angles between 45° and 60° are common, in the USA 30° and in Great Britain 52° (**figure 72**).

If a rope travels over a sheave under a fleet angle, it will roll down the flanges and get twisted. Tests have shown that the amount of twist brought into the rope is a function of the groove angle: The larger the groove angle, the less twisting will occur.

A steel wire rope diameter can measure up to nominal rope diameter +5 %. In order to accommodate a steel wire rope, according to ISO 16625 the groove diameter should therefore measure between nominal rope diameter +5 % to +10 %, in the ideal case +6 %.

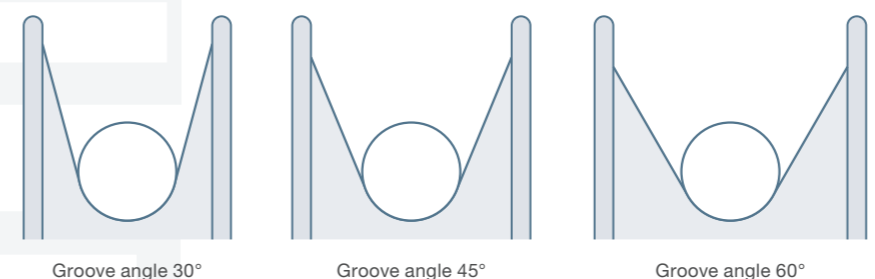

**Figure 72:** Different groove angles of sheaves

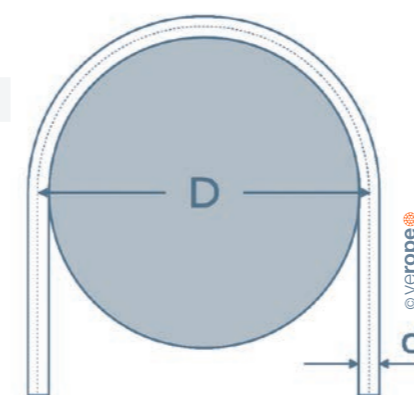

**Figure 73:** Sheave diameter



**Figure 74:** Groove gauge (shown in a too narrow groove)

verope® offers groove gauges to measure the actual groove diameter (**figure 74**).



# CHOOSE THE RIGHT ROPE FOR YOUR APPLICATION

Two views have to be matched to select the right rope: the application and the rope point of view!

The "universal rope" that is suitable for all applications does not exist. Therefore there are a variety of different rope constructions that best meet the requirements for a given duty.

With the following remarks we want to give some practical information to help choosing the right crane rope depending on the application.

Needless to say that whenever you are in doubt the verope® team is happy to assist.

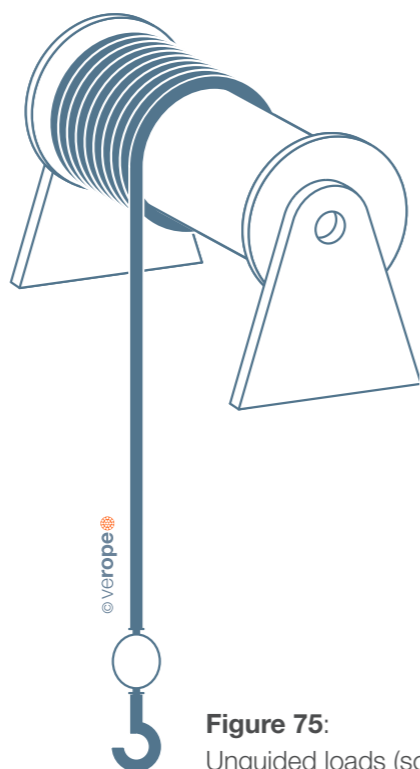

**Figure 75:**  
Unguided loads (source VDI 2358)

## 6.1 APPLICATION VIEW

The main purpose of a crane is without any doubt to hoist something from place/level A to B, for which you need a **Hoist rope**.

Besides the crucial "Hoist application" a wide variety of other functions, depending on the crane type itself, is needed to operate a crane, e.g.

- Luffing ropes to position the boom
- Trolley ropes to move the load on tower cranes or container cranes
- Pendant ropes to hold the boom or other crane structures
- Installation ropes to mount or dismantle the crane
- ... and others

## 6.2 ROPE VIEW

From the technical point of view there are two main categories, crane ropes can be divided into, when focusing on the rope application in cranes:

- rotation-resistant ropes
  - Sometimes colloquially also named as non-rotating ropes or multi-strand ropes
- Non-rotation resistant ropes

### "Hoist Application"

As a basic guidance the following rule has proven it's worth:

For all "Hoist applications", either main or auxiliary hoists, rotation-resistant Ropes are used exclusively, when:

- the load is unguided (**figure 75**) and/or
- high lifting heights are required

Only rotation-resistant ropes provide load stability so the load has no or little tendency to rotate. Rotation-resistant ropes that are fixed to the crane construction transmit no or little torque to the attachment point. Therefore rotation-resistant verope® special wire ropes guarantee safe operation.

Ropes, that are defined as rotation-resistant according to the specified standards, vary regarding their resistance to rotation (depending on the construction type).

To show the difference regarding resistance to rotation, different "classes" are formed. For example EN 12385-4 nominates the rope class "35x7", which describes rotation-resistant ropes having three layers of strands and the rope class "18x7", which describes rotation-resistant ropes having only two layers of strands. The rotation resistance of both classes, as well as the production cost clearly differ and the prices will vary accordingly.

In addition, as a further example, the ASTM A 1023 describes three rope categories, categorized by their resistance to rotation. Please find the two categories "1"

and "2", that are widely used as hoist ropes in cranes:

- Category 1 - rotation-resistant ropes have at least 15 outer strands and provide best resistance to rotation
- Category 2 - rotation-resistant ropes have 10 or more outer strands

As general guidance rotation-resistant ropes considered being "35x7"-class ropes provide comparable resistance to rotation as category 1-ropes according to ASTM A1023 whereas rotation-resistant ropes considered being "18x7"-class ropes provide comparable resistance to rotation as category 2-ropes according to ASTM A1023.

For demanding applications category1-rotation-resistant ropes have to be used.

**Please Note:** Ropes of the class "35x7"/ category 1 have to always be replaced by ropes of the same/comparable class and **never** by ropes of class "18x7"/category2. Whereas ropes of the class "18x7"/category2 can also be replaced by ropes of category 1/"35x7" from a technical point of view.

**Information:** In addition to rotation-resistant ropes, which are manufactured according to national or international standards, there are many rotation-resistant ropes designed and manufactured "besides" the standard to meet even higher demands. These are real Special Wire Ropes, developed for the highest demands regarding rotation resistance, for example the highest lifting heights of modern cranes. To give customers general guidance about such special ropes the above mentioned standards are used as a reference to classify special ropes because the fundamental properties are comparable, although the performance is better.

**Important:** When rotation-resistant ropes are required, they must never be replaced by non-rotation-resistant ropes.





### Usage of a swivel on hoist ropes

The usage of a swivel can be helpful to eliminate twist generated under certain circumstances within the rope drive, e.g. if fleet angles between the drum and the first sheave or between the sheaves are in some configurations above recommended limits. In multi-reeving applications, the swivel can't compensate twist in all falls but at least the first falls from the swivel. The swivel reduces the risk of either hook cabling or rope damages like waviness or basket deformation that can lead to rope discard.

Please note that ropes considered to be "35x7"- class ropes/category 1-ropes according to ASTM A1023 could be used with or without a swivel.

EN 12385-3 and ISO 21669 give further information regarding the swivel usage.

**verope®'s product range of rotation-resistant ropes** contains the high-performance products, that are part of the "-top"-series:

- verotop P
  - verotop XP
  - verotop
  - verotop S
  - verotop E
- and the 4-strand rope construction
- vero 4

With the exception of the 4-strand rope vero4 all our ropes are high performance category-1 rotation-resistant ropes, providing best resistance to rotation.

All "top"-series crane ropes can be used either with or without a swivel.

The vero4-product, a very robust rope, is designed for harshest working conditions with dynamic impact loads. Although the vero4 rope is part of the rotation-resistant group the vero4-product may not be used with a swivel.

The basic rule for "Hoist application" is to use rotation-resistant ropes.

Following that rule you can't fail but as with all rules there are exceptions under certain circumstances:

1. For "Hoist application" and guided loads non-rotation resistant ropes can be used too because the torque generated under load is held by the frame, guiding the load (**figure 76**).
2. For "Hoist application" and unguided loads non-rotation resistant ropes can be used too, when the same rope construction ropes are used as a pair that consists of right and left hand ropes (**figure 77**).

The second configuration also provides rotational stability, so the load has no or little tendency to rotate, because the amount of torque generated under load is equal, but in opposite directions: the result – torque equilibrium.

**Important:** Rotation-resistant ropes are clearly inferior regarding the bending cycle performance in comparison to non-rotation-resistant ropes. Therefore non-rotation-resistant ropes should only be replaced by rotation-resistant ropes under utmost care and after consulting with rope experts.

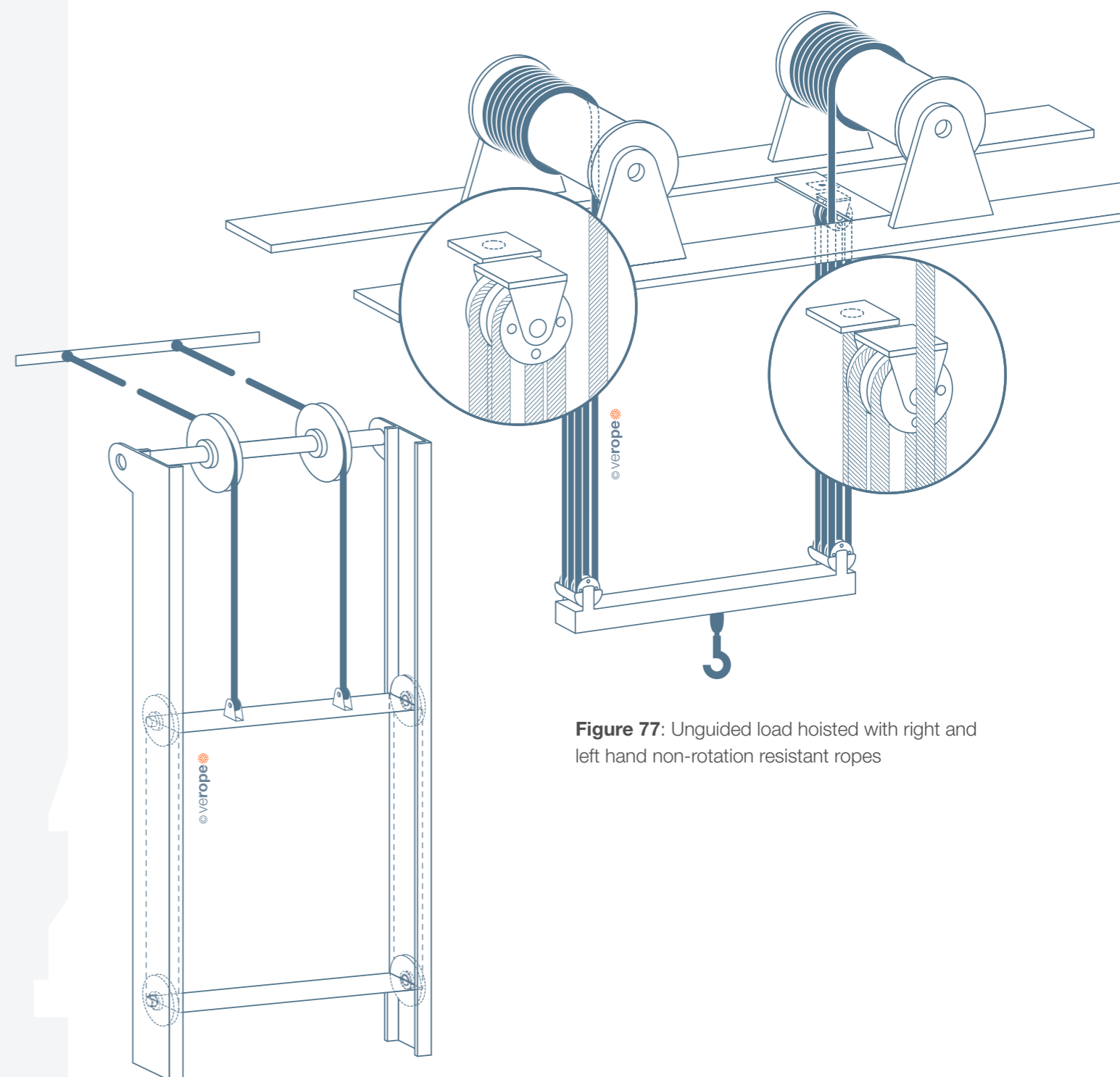

**Figure 76:** Guided load (VDI 2358)

**Figure 77:** Unguided load hoisted with right and left hand non-rotation resistant ropes



### More crane applications

Non-rotation resistant ropes usually achieve more bending cycles than rotation-resistant ropes or semi-rotation resistant ropes. However, they exert a torque on the end connection when under load.

Therefore non-rotation resistant ropes can only be used, if the ends of the ropes are permanently protected against twisting.

Non-rotation resistant ropes are always the right choice, when the characteristic "rotation-resistance", which only rotation-resistant ropes offer, is not required. This is the case for many rope applications, e.g. for luffing ropes, trolley ropes, pendant ropes or installation ropes.

**Note:** With coupling of non-rotation resistant ropes, e.g. pendant ropes or grab ropes, only identical ropes of the same construction, meaning: the same diameter, the same lay type and lay direction have to be used (figure 78).

Combining ropes with different lay directions would turn up the ropes and thus destroy them.

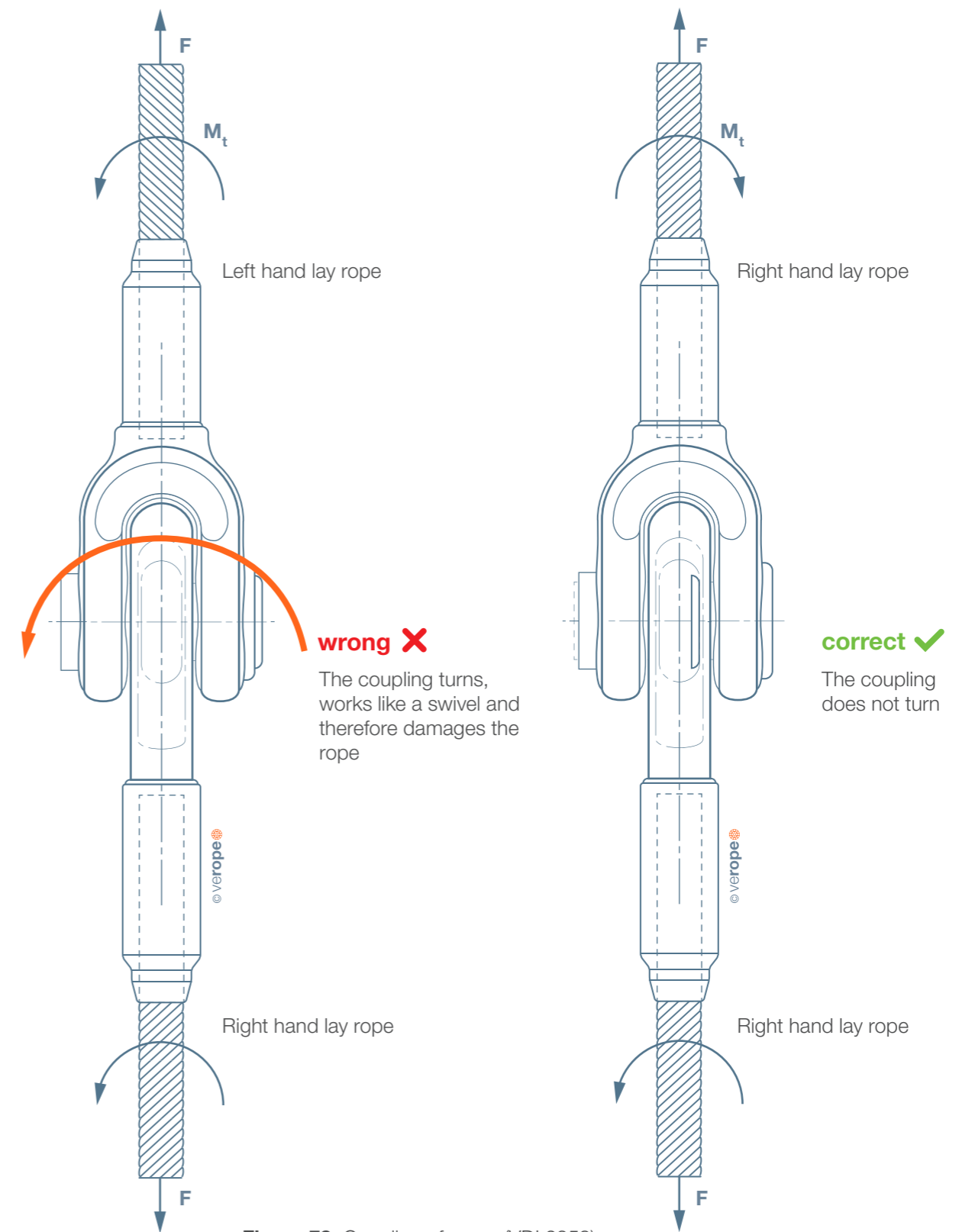

Figure 78: Coupling of ropes (VDI 2358)



## 6.3 APPLICATION OF REGULAR (OR ORDINARY) AND LANG'S LAY ROPES

The choice of the lay type must consider the specific use of the rope, the rope construction, crane components and the expected wear factors in use, which determine the lifetime of the rope substantially. The aim of the rope choice is a high rope lifetime ensuring a high safety factor at the same time, which means the operator can recognize the secure operating condition of the rope reliably at any time, considering the discard criteria of the specific application. Therefore a general statement about the use of regular or lang's lay ropes is not possible or not useful without knowledge of the specific case/application.

### Ordinary (regular) lay ropes

Ordinary lay ropes are widespread which are therefore presumably considered as universally applicable. Ordinary lay ropes have a very good structural stability due to the opposing stranding of the wires and strands which make them more resistant against external twist. The rope torque is lower than the one of lang's lay ropes. Ordinary lay ropes also offer a good wear-resistance. Construction wise the externally visible wire breaks appear earlier of ordinary ropes than of lang's lay ropes due to the higher pressure between wire and rope groove and a stronger wire bend within the strand, which makes it easier to recognize wire breaks and thus the rope state, making it easier to evaluate the discard criteria. Ordinary lay ropes are still no universal ropes for all applications under the abovementioned aims of the rope choice.

### Lang's lay ropes

Lang's lay ropes are more demanding not only in the production process, but also with the application, beginning with the installation. The reason for this lies in the stranding of wires and strands in the same direction, which raises the rope torque and makes lang's lay ropes substantially more sensitively against every kind of external twist.

Lang's lay ropes reach very high bending cycles until break because of the geometrically more favorable contact conditions between wire and rope groove which leads to the reduction of the pressure in the contact areas. This reduction of pressure is advantageous to the lifetime of the crane components and the rope itself.

However, it must also to be mentioned, that in comparison to ordinary lay ropes the development of the externally visible wire breaks occurs more slowly. Therefore the recognition of the discard criteria due to externally visible wire breaks can be complicated. For this reason the numbers of wire breaks until discard are clearly lower for lang's lay ropes than for ordinary lay ropes with identical rope construction. Therefore also lang's lay ropes are not universal ropes for all applications under the abovementioned criteria of rope choice.

**Important:** As described in the "Lang's Lay ropes" paragraph, these ropes can have an increased amount of internal wire breaks, which are not visible on the outside. This is especially the case with rotation-resistant ropes in Lang Lay under bending cycle usage. This should always be clarified with a rope expert.

### Crane components and crane geometry

Besides the rope itself crane components and crane geometry are important criteria for the right rope choice. The applied drum system and the crane geometry constructively selected fleet angles are to be mentioned particularly.

While on single-layer drums the rope gets stressed due to tensile load and substantially due to bending and lateral deflection and thus twists, mechanical wear and lateral pressure between the touching ropes dominate on multi layer drums.

The crane geometry's constructively selected fleet angle is a very important characteristic for a reliable rope spooling and the degree of rope wear. For multi-layer spooling a maximum fleet angle of 1,5° is recommended, while single-layer drums can work with higher fleet angles like for example up to 4°. Consequently the right rope choice is to be matched with these operating-/wear conditions.

The following basic rules for the correct choice of rope lay types for ropes that spool on drums have proven themselves and therefore are also recommended by us:

- single-layer drums = ordinary lay ropes
- multi-layer drums = lang's lay ropes

On single-layer drums, the ordinary lay rope has clear advantages, because it can usually compensate bigger fleet angles. Also the easier recognition of externally visible wire breaks is an important argument for the use of ordinary lay ropes on single-layer drums where strong mechanical rope wear, which also leads to wire breaks, does not or at least not substantially exist. On multi-layer drums the bending fatigue resistance of the rope is not decisive for the rope lifetime but its resistance to mechanical impact is. Ordinary lay ropes are less suitable for multi-layer drum spooling because the wires of the neighboring ropes can rub with each other. This leads to high mechanical wear. The touch of the neighboring ropes during the spooling process is also well "audible". This results in premature wire breaks. Lang's lay ropes have proven themselves in multi-layer spooling because neighboring ropes can not rub into each other, which raises the lifetime of the rope significantly.

The use of ropes with compacted outer strands and/or rotary swaged rope constructions can clearly raise the rope lifetime due to the very smooth surface and the high resistance to abrasion.

The abovementioned statements have proven themselves in practice. Customer desired, occasional divergences should therefore be analyzed thoroughly with regard to:

- specific operating conditions of the rope
- the chosen rope construction
- the customer's rope supervision concerning discard criteria before a divergent decision can be made.



# ROPE REQUIREMENTS FROM THE CRANE VIEW

When selecting a rope, it should always be checked carefully, which operating condition and (as a result) which stresses on the rope dominate from the crane point of view. These demand relations differ clearly and justify the manufacturing of special wire ropes, meaning application-specific solutions, which can fulfill precisely these dominating demands in the best way possible.

Of course there are ropes, which already cover the essential demands of their construction class quite well. From our product range we can name the veropro 8 for the non-rotation resistant application range or the verotop for the rotation-resistant application range.

There are of course also the distinct "specialists", ropes with special strengths on which you can rely on with regard to dominating demands like wear-resistance, radial stability or bending fatigue strength.

With the following representation, based on the dominating demands to the ropes in the crane, which you have to determine first, we would like to provide

you with instructions for the necessary rope qualities (based on the dominating demands) of the specialist under the verope® special wire ropes.

The representation, an imagery rope cross-section, should also make clear figuratively that there is no such rope that can fulfill all special standards equally and in the best way possible.

**With pleasure we support the selection of the best rope for your application!**

## THE MAGICAL ROPE

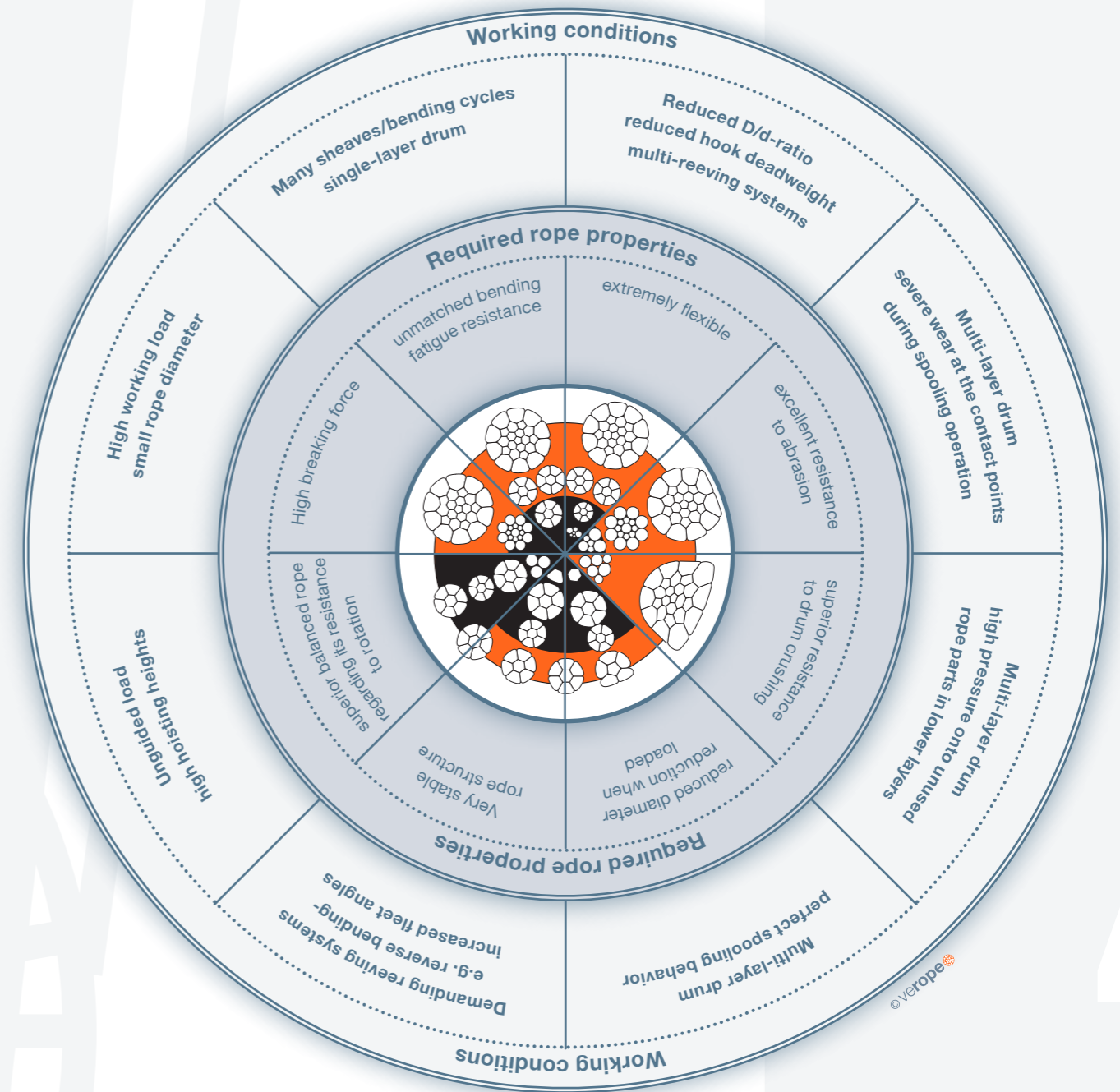



# ROPE END CONNECTIONS

## 8.1 POINTS OF REFERENCE TO DETERMINE THE ROPE LENGTH PRECISELY

For some rope applications, e.g. pendant ropes, the rope length is essential. The following terms are used to describe the points of reference that are important to determine the rope length precisely. Some typical examples are added. By using the terms we want to make sure, that misunderstandings can be avoided.

Besides the points of reference, the force under which the length must be correct shall also be determined by you. Without any information about the force, it is automatically assumed, that the length shall be correct at  $F=0\text{ kN}$ .

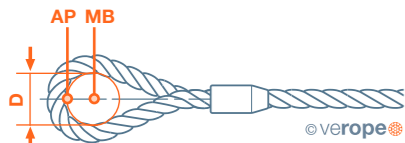

Flemish eye ferrule-secured termination

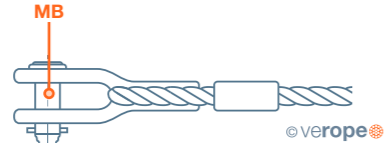

Ferrule-secured open thimble termination

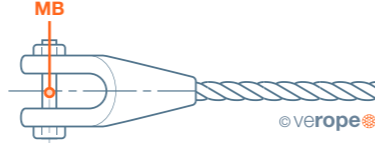

Open spelter socket: Metal or resin socketing

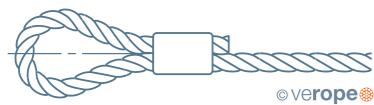

Ferrule-secured thimble termination

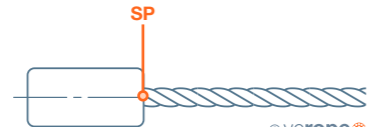

End stop: either metal/resin socketing or swaged

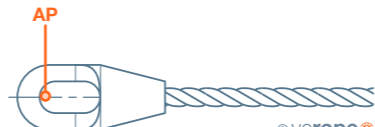

Closed end socket: Metal or cast synthetic resin

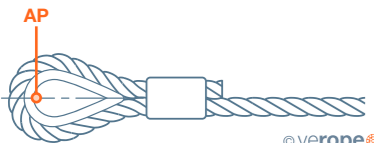

Ferrule-secured eye termination

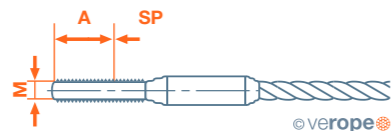

Threaded socket swaged

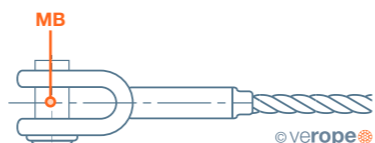

Open socket swaged

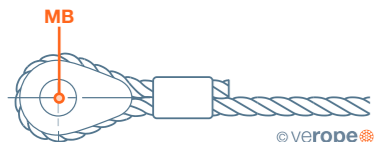

Ferrule-secured solid thimble termination

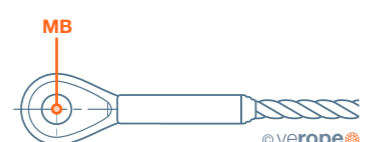

Closed socket swaged



Pad eye



Seized and cut



Fused and tapered

Abbreviation	Point of reference
AP	Attachment Point
MB	Mid bolt
SP	Support point

## 8.2 EFFICIENCY FACTOR $K_T$ OF ROPE END CONNECTIONS

The minimum-breaking load given in the data sheet is "... specified value in kN, below which the measured breaking force ( $F_m$ ) is not allowed to fall in a prescribed breaking force test ..."  
(according to DIN EN 12385-2, 3.10.10).

In particular for the crane designer it is important to know which influence a chosen end connection has on the transferable breaking strength of the rope end connection system. The minimum test strength that should be reached when examining a rope end

connection in a pull test, is determined with regard to the minimum breaking strength of the rope and considering the efficiency factor  $K_T$ .

$K_T = 0,9$  means, the test strength that has to be achieved must be at least 90% of the minimum breaking force of the rope.  
Unless otherwise indicated, the following basic rules apply:  
 $K_T = 1,0$  for casted rope end connections  
 $K_T = 0,9$  for pressed rope end connections

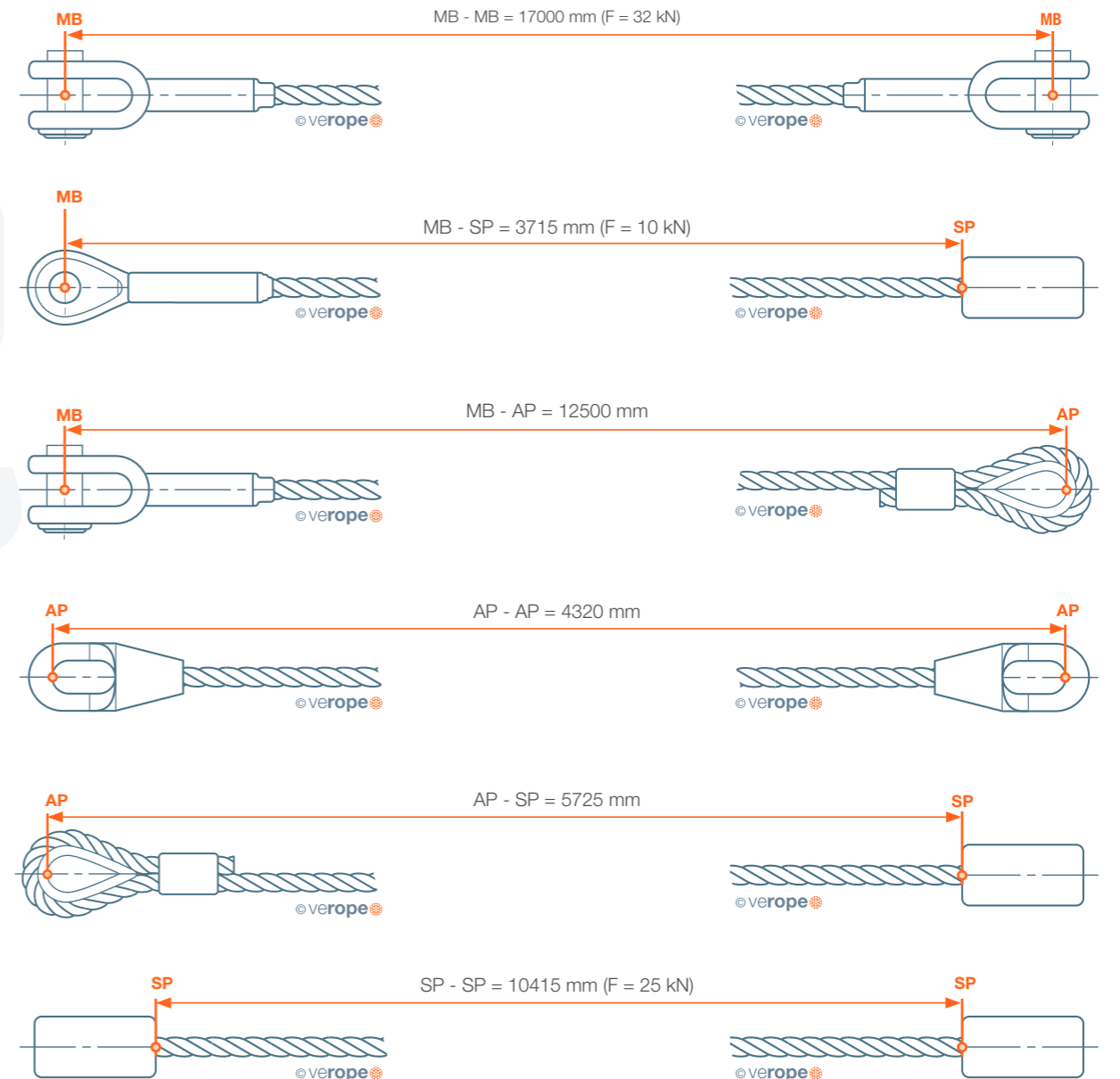



# GENERAL INFORMATION

## 9.1 HANDLING AND STORAGE OF ROPES

### Handling of reels

The reels should be transported by using suitable lifting gear, like lifting ropes, slings, chains or crossbeams respectively with fork lifts. For the transport of light rope rings, textiles lifting belts or slings are suitable. Please avoid touching the rope during the reel handling. This can already lead to mechanical damages of the rope.

### Rope storage

Wire ropes are to be protected against dirt and humidity during storage. Ideally they are stored in suitable halls. During storage the reels are to be secured against rolling away. During storage outside, they are to be protected against humidity and other environmental factors in the best possible way. Please note, that the cover of the reels should ensure, that the rope under it is always ventilated enough in order to avoid corrosion due to condensation.

Please do not put the rope directly on the ground, but rather on a pallet. Ungalvanized ropes should not be stored outside for a longer time. With unfavorable storage terms, like for example too high temperatures, it can be necessary that the ropes have to be re-lubricated before use.



## 9.2 INSTALLATION OF WIRE ROPES

The installation of a rope should always be prepared in the best possible way.

### Control of the new rope

The new rope is to be controlled with regard to the construction and the lay direction of the rope, moreover the effective rope diameter shall be measured. This information should also be compared to the delivery documents.

The following graphic shows the correct allocation of the lay type of the rope, right hand or left hand lay, to the present drum, which winds the rope from above (overwind) or from underneath (underwind). Drums can be divided into right hand and left hand lay. The proven rule for the right rope choice says, that a right hand lay rope should be used on a left hand lay drum and vice versa. This is valid for all single-layer drums. We recommend following this rule also for multi-layer drums.

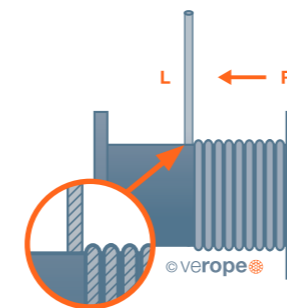

**Case A:** Unwinding direction is from right to left.  
Left hand lay drums require right hand lay ropes

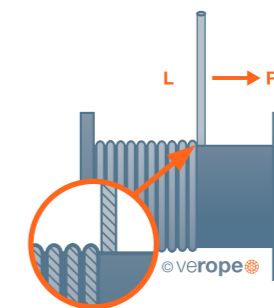

**Case B:** Unwinding direction is from left to right.  
Right hand lay drums require a left hand lay ropes

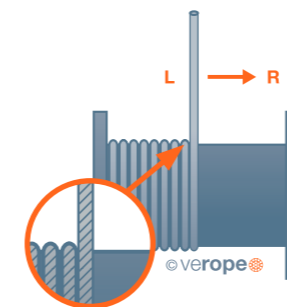

**Case C:** Overwind: winding direction is from left to right.  
Left hand lay drums require right hand lay ropes

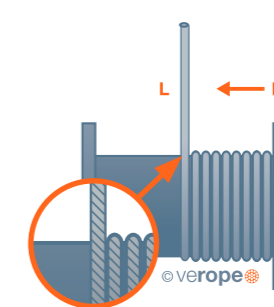

**Case D:** Overwind: winding direction is from right to left.  
Right hand lay drums require left hand lay ropes

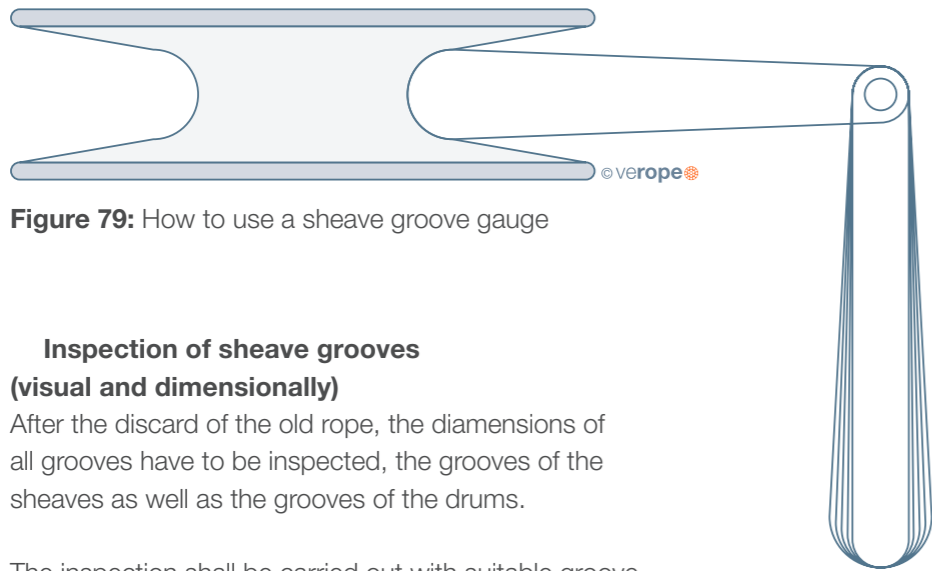

Figure 79: How to use a sheave groove gauge

**Inspection of sheave grooves (visual and dimensionally)**

After the discard of the old rope, the dimensions of all grooves have to be inspected, the grooves of the sheaves as well as the grooves of the drums.

The inspection shall be carried out with suitable groove gauges. Damaged or sluggish sheaves should always be exchanged or remachined.

**Possible outcomes of the groove inspection**

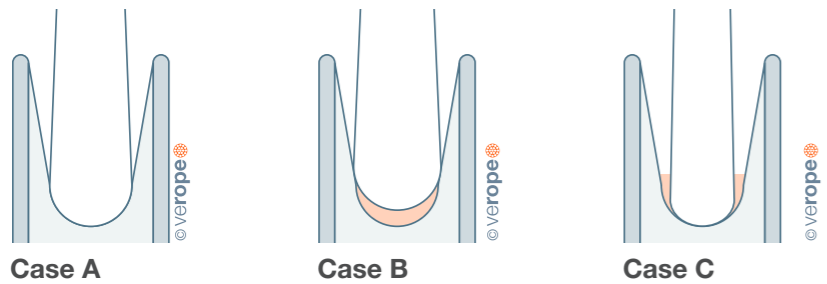

**Case A:** The groove is ok.

**Case B:** The dimension of the groove is smaller than required by the standard. In this case the rope should not be installed because it would be clamped and therefore damaged in the groove. Inevitable damages of the rope structure would be the consequence.

**Case C:** Although too big sheave grooves reduce the lifetime of a rope, it is practically not that severe, so initially this must not have any consequences.



**Rope Installation Process**

The rope installation has to be done very carefully and always by well trained and experienced staff. Please ensure you observe the following points:

1. While ropes that are delivered on a ring can easily be laid out, ropes which are wound onto drums have to go over suitable unwinding devices like a rotary table or a pay off machine.

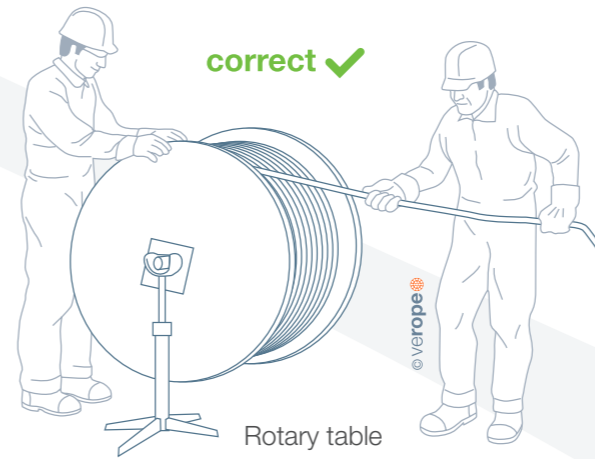

2. Never pull the rope off the ring or the reel.

This introduces twist into the rope.



3. At some rope installations, the insertion of the new rope takes place with the help of the old rope. In particular with the change of rotation-resistant hoist ropes, the connection between the two ropes should be chosen in such a way, that the twist that may be in the old rope couldn't be transferred to the new rope. This can be achieved for example by connecting the two ropes over a swivel.

4. Note the winding direction! Please position the delivered reel in such a way, that the winding direction of the rope remains the same. Avoid opposing winding directions with reverse bending during the rope installation.

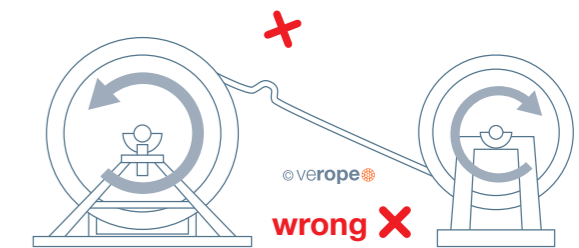
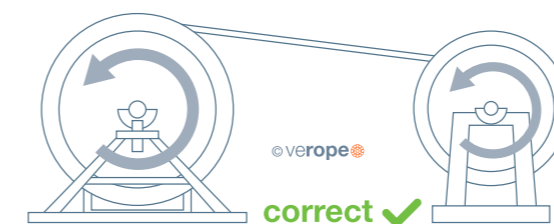



**5.** Please check the complete reeving area before starting the winding process in order to make sure that the rope was reeved correctly during the installation process and is not let over any edges.

**6.** Wind and unwind the rope always in a controlled way. We recommend that a person should control the unwinding process of the delivered reel that has audio contact with the crane operator, in order to be able to stop the installation process in case of disruptions at any time.

**7.** How to dismantle the rope end from the delivered reel: Please interrupt the installation process, when on the delivered reel there are about 5 winds left on the first winding layer in order to dismantle the end connection or rope end respectively, that may be positioned inside the reel. Continue afterwards at a very low winding speed and stop shortly before the endpoint. Stop the installation process and dismantle the end connection or the rope end.

#### Initial operation after the installation process

Once the installation process is completed, we recommend a complete reeving of the rope one time. The whole rope length should be moved under low load over all sheaves. This ensures that the rope elements settle within the rope structure. We ask you to repeat this process several times so that the rope is prepared for the application in the best way possible.

With multi-layer spooling the rope is to be winded under preliminary tension, which is explained in the following section.

#### Rope installation with multi-layer spooling

The installation of a rope on a multi-layer drum is particularly challenging! With very big rope length or with an initial installation the whole installation process should be planned thoroughly. This is also valid if the rope lengths are to be put on the crane drum, of which it is known, that after the rope installation a new winding and unwinding is not possible because of the temporary crane configuration – please see also "initial operation".

A brake shall always be applied on the delivered reel. The breaking force shall be chosen in such a way that the rope winding on the delivered reel will not be destroyed. The generated brake tension makes the winding onto the crane drum much easier. But it usually does not reach the preliminary tension for multi-layer spooling, which is considered necessary. Please see following explanation.

If there are no tools to generate braking force available, the rope should be put on the crane with as little load as possible. The braking power may on no account be generated by clamping the rope, because this can lead to heavy rope damages already during the installation process.

#### Importance of preliminary tension of ropes with multi-layer spooling

In multi layer spooling the correct preliminary tension of the rope is essential in order to assure good spooling behavior and minimized wear on the rope in the lower winding layers, which are heavily stressed due to the pressure.

Practical experience has shown that a preliminary tension of the rope of about 10% of the nominal rope load has a sustainable positive impact. If this preliminary rope tension cannot be realized due to the rope lengths and/or the crane configuration, then a lower preliminary tension is also helpful, although not as effective as the 10%.

Signs for insufficient or missing preliminary tension of the rope are winding disturbances which are caused by gap formation due to compressive loading of the ropes which are moving under the winding layers. If this condition is not corrected, cutting in of the rope lines may occur and therefore damage the rope heavily even to the extend of reaching its discard criteria.

Therefore please renew the preliminary rope tension over the entire rope length regularly, at the latest when recognizable winding disturbances occur, over the whole rope length. This can help extend the lifetime significantly.

In the multi-layer spooling special wire ropes, especially rotation-resistant hoist ropes, work most economically if the installed rope length on the crane is used on a regular basis.

Should certain rope areas not be used regularly because of the working condition or the crane configuration, the application of an adapted rope length is recommended in order to avoid possible rope damages.





# SAFETY INSTRUCTIONS

PLEASE NOTE THAT WRONG SELECTION AND USE OF WIRE ROPES CAN BE DANGEROUS!

**PROTECT YOURSELF AND OTHERS!**  
FAILURE OF WIRE ROPE OR WIRE ROPE TERMINATION MAY CAUSE SERIOUS INJURY OR DEATH!

With the following information, we would like to bring your attention to a few key points for proper selection, use and monitoring of wire ropes. In addition to general technical literature on wire ropes, national and international standards your verope® team is happy to assist regarding all rope related questions you may have.

**Don't hesitate to contact us!**

- Wire ropes must be properly transported, stored, set up and maintained. Please refer to the relevant literature on these topics.
- Always inspect wire ropes and wire rope terminations with regard to wear, damage or abuse before use! Never use wire ropes or wire rope terminations that are worn out, damaged or abused!
- Never overload or shock load a wire rope.
- Please note that very high or very low ambient temperatures may dramatically change the behavior of the wire rope as well as the wire rope termination. Please contact us if there is any doubt regarding the safe use in a certain environment.
- Please note that any termination assembled by verope® must not be modified!
- Wire ropes and wire rope terminations are not fatigue-proof. For safe and proper use, maintenance and inspection are required. Wire ropes and wire rope terminations have to be discarded when the results of inspection indicate that a further use would be unsafe. Please refer to applicable international or national standards in their relevant version (e.g. ISO 4309, EN 12385 and EN 13411), and other general technical literature or regulations concerning inspection, examination and discard criteria for both wire ropes and wire rope terminations.
- Our products are subject to modifications, this may change the specifications. Relevant is always the data on our website.
- The cross-section on our data sheet shows a typical rope diameter and can vary within the range.



# USE OF METRICAL ROPES ON IMPERIAL CRANES AND OF IMPERIAL ROPES ON METRICAL CRANES

When using mm-ropes on inch-cranes or vice versa, often the wrong rope diameter is selected. Here the following selection table is valid.

The table is to be used in the following manner:

**Case 1:** The crane has a sheave or drum that is dimensioned for imperial ropes (unit: inch) and a metrical rope (unit: mm) has to be installed. For the inch-diameter in the left column the nominal rope diameter can be chosen in mm from the right column if it is shown in the same color.

**Example:** If the sheave or the drum was laid out for a nominal rope diameter of 1 1/4 inch, a rope can be used with the nominal rope diameter of 32mm. If the rope diameter in the right column is shown in a different color, the next smaller nominal rope diameter has to be chosen in mm, presumed the demands for minimum breaking strengths are fulfilled.

**Example:** If the sheaves or drums are laid out for a rope of the nominal diameter 1 inch, a metrical rope of the nominal rope diameter of 25mm has to be used.

**Case 2:** The crane has a sheave or drum that is dimensioned for metrical ropes (unit: mm) and an imperial rope has to be installed. For the mm diameter in the right column the nominal rope diameter can be chosen in inch from the left column if it is shown in the same color.

**Example:** If the sheave or the drum was laid out for a 32mm rope, a 1 1/4 inch rope can be used. If the rope diameter on the left side is shown in another color, the next smaller nominal rope diameter of the inch column has to be chosen, presumed the demands for minimum breaking strengths are fulfilled.

**Example:** If the sheave or the drum was laid out for a rope of the nominal diameter of 26mm, an imperial rope of the nominal diameter of 1 inch has to be chosen.

## CONVERSION TABLE

Ø inch	Ø mm
0,236	6
1/4	6,350
0,276	7
5/16	8
0,354	9
3/8	9,525
0,394	10
7/16	11
0,472	12
1/2	12,7
0,512	13
0,551	14
0,591	15
5/8	15,875
0,630	16
0,669	17
0,709	18
3/4	19
0,787	20
0,827	21
7/8	22
0,906	23
0,945	24
0,984	25
1	25,400

Ø inch	Ø mm
1,024	26
1,063	27
1,102	28
1 1/8	28,575
1,142	29
1,181	30
1,220	31
1 1/4	32
1,299	33
1,339	34
1,378	35
1,417	36
1,457	37
1 1/2	38
1,535	39
1,575	40
1 5/8	41,275
1,654	42
1,732	44
1 3/4	44,450
1,811	46
1 7/8	47,625
1,890	48
1,969	50
2	50,800

©verope

<b>Length</b>	1 m	1000 mm	39,37 inch	3,281 feet	
	1 mm	0,03937 inch	0,003281feet		
	1 feet	304,8 cm	0,3048 mm		
	1 inch	25,4mm	0,0254mm		
<b>Force</b>	1 kN	1000 N	101,972 kg	0,101972 ton	224,8089 lbf
	1 kg	9,80665 N			
	1 short ton, 2000 lb	907,185 kg			
	1 long ton, 2240 lb	1016,047 kg			
<b>Mass/Weight</b>	1 ton	1000 kg	2204,623 lbs	1,102 short ton, 2000 lb	0,9842 long ton, 2240 lb
<b>Approx. Weight</b>	1 kg/m	0,672 lbs/ft			
<b>Tensile Grade</b>	1 N/mm <sup>2</sup>	0,10197 kp/mm <sup>2</sup>			



# VEROPE® SERVICE CENTER GMBH

## verope® – rely on

verope® AG, founded in 2004 as a joint venture company of Pierre Verreet and Kiswire, stands for high quality special wire ropes you can rely on. Together we will continue to focus on development of high quality products – the next generation of special wire ropes.

## verope® Service Center GmbH

Beginning of 2011, verope® introduced a new strategic service concept for the European market. Substantial investments into the new Service and Logistics Center in Contwig/Germany enable verope® to stock, process and supply rope systems out of its wide special wire rope portfolio in high quality and with short lead times.

Efficient and controlled wire rope processing is an essential part of our activity in our German location. Here we combine technical know-how and experience in process engineering to assemble special wire ropes with standard and/or verope® designed endterminations according to customer requirements.

The verope® Service Center Team is pleased to provide our customers high qualified services you can rely on at any time.

## Technical Department

Another important activity of the verope® Service Center is the technical department, separated into the divisions endterminations, rope testing and Global Technical Customer Service.

A strategic target of verope® is to accompany its special wire ropes during its usage until discard.

## We offer:

- Technical customer service
- Technical advice including Analysis, e.g. theoretical lifetime calculations
- Rope & Crane inspections (reeving system) and Reporting
- Damage analysis
- Training and Seminar
- Different kinds of testing, in our own testing facilities such as:
  - Tensile test up to 2500 kN
  - Bending fatigue test for various rope diameters
  - Various tests to determine the rotational behavior of ropes
  - Elongation measurement
  - Modulus of elasticity determination
  - Rope flexibility tests
  - Measurement of the diameter reduction under load
  - Radial Stability
  - Tension-tension fatigue test

Through our permanent improvements in production processes and the investments in our infrastructure, the verope® Service Center is the main hub for our OEM customers and our competence center for all our global service center concepts.

We are prepared to provide more details of our concept and to prove the benefits for our valued customers.



verope® Service Center with R&D



# VEROPE® WORLDWIDE

## SERVICE AND DISTRIBUTION

With our stock-keeping program at the different verope® Service Centers, we are able to bridge the distance between our modern rope production facility and joint venture partner Kiswire in both South Korea and Malaysia and our customers day to day requirements locally. Our service and logistics centers are able to turn on short notice any inquiries into action.

- ① verope® AG (Headquarters), Zug, Switzerland
- ② verope® Service Center GmbH, Contwig, Germany
- ③ verope® France, Paris, France
- ④ verope® UK, Birmingham, UK
- ⑤ verope® Distribution Singapore Pte. Ltd, Singapore
- ⑥ verope® USA, Houston, USA
- ⑦ LTI Steel Wire Rope Co., Ltd., Shanghai, China
- ⑧ verope® do Brasil, Resende, RJ, Brazil
- ⑨ verope® Steel Wire Ropes Private Limited, Mumbai & New Delhi, India
- ⑩ verope® Middle East, Dubai, UAE

VEROPE® HAS A WORLDWIDE NETWORK OF PROFESSIONAL DISTRIBUTORS WHO EXPERTLY SELECT THE CORRECT HIGH PERFORMANCE ROPE TO SUIT YOUR REQUIREMENTS REGIONALLY.



## **TECHNICAL BOCHURE**

Edition April 2019

All rights reserved.

Copyright 2019 verope® AG.

Reprint or reproduction of any material in part or in whole only with express written consent of the publisher.

Printed on environmentally friendly FSC® paper.

**verope** ®  
rely on

### **verope® AG**

St. Antons-Gasse 4a

CH-6300 Zug / Switzerland

Tel: +41 (0) 41 72 80 880

Fax: +41 (0) 41 72 80 888

**[www.verope.com](http://www.verope.com)**

**[info@verope.com](mailto:info@verope.com)**