

verope ®

# APPROPRIATE HANDLING OF VEROPE® SPECIAL WIRE ROPES

verope® special wire ropes

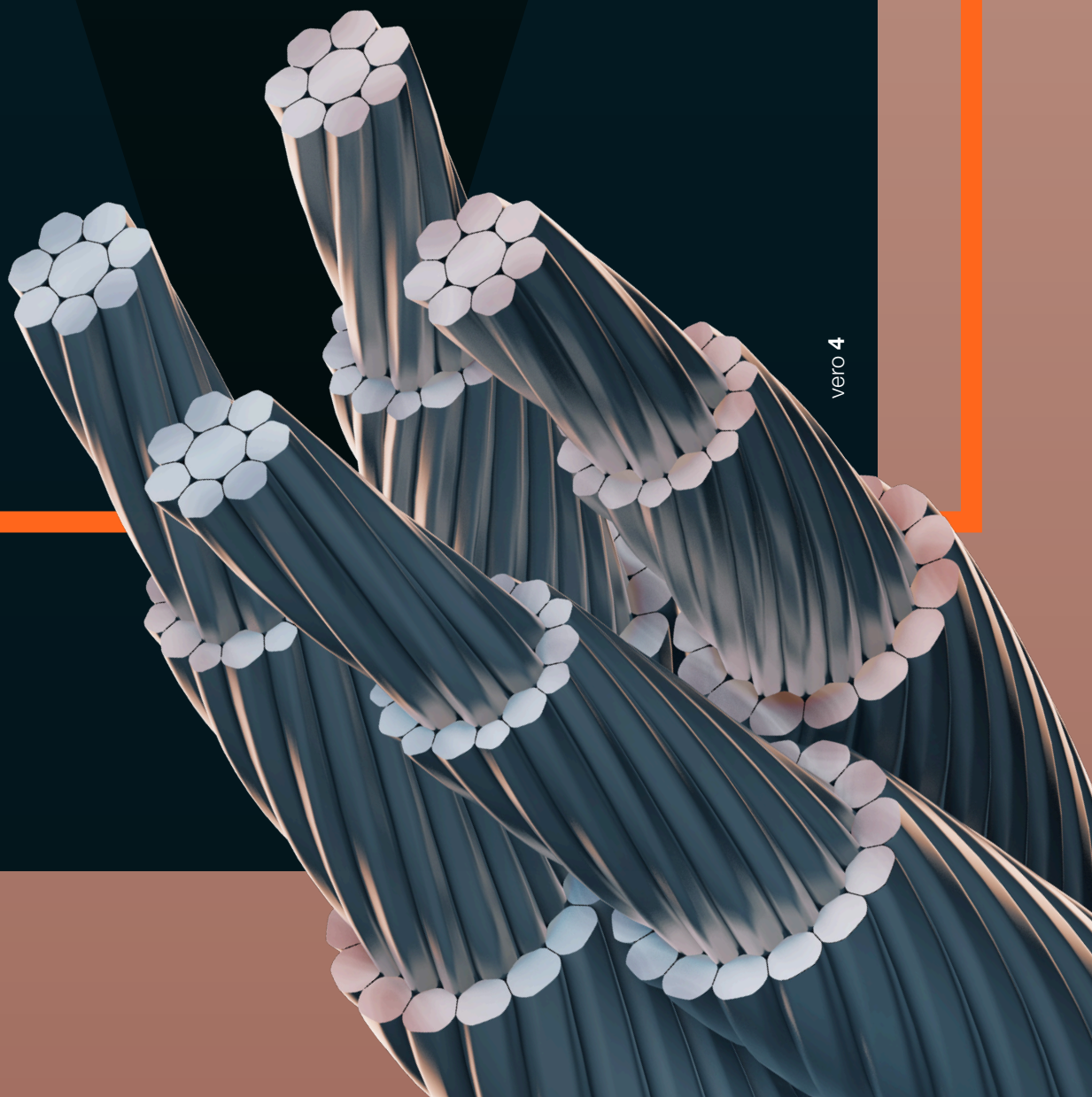

vero 4



# ORIGINAL OPERATING MANUAL

## FOR VEROPE® SPECIAL WIRE ROPES ACCORDING TO MACHINERY DIRECTIVE 2006/42/EC

### EC Declaration of Conformity

We hereby declare, that the equipment sold by us because of its design and construction, as mentioned below, corresponds to the appropriate basic requirements of safety and health of the corresponding EG-Machinery Directive 2006/42/EC, as well as to the harmonized and national norms, also mentioned below, and technical specifications. In case of any equipment modifications, not being agreed upon with us, this declaration becomes invalid. The applied harmonized standards as defined by the Machinery Directive 2006/42/EC are EN 12385 Part 1-4 for the wire rope and EN 12411 Part 1-8 partly or as whole for the wire rope end terminations.

verope® special wire ropes are stranded ropes for general lifting applications. There is a huge variety in terms of size and shapes of the verope® wire rope and end termination systems. This operating manual only describes the systems in general without going into detail of all possible variations.

### SAFETY INSTRUCTIONS



**Danger:** It is absolutely necessary to wear a safety helmet, safety glasses, safety shoes and work gloves when working with ropes. Protruding wires can cause serious skin injuries. Energetically charged ropes can cause head, eye and body injuries. Lubricants and their solvents can irritate the skin surface.

### ROPE SELECTION



**Danger:** Rope selections made contrary to expertise or generally applicable regulations have an accelerated failure mechanism. In extreme cases, an incorrect rope selection can lead to unpredictable rope breakages, causing the most serious accidents.

**Note:** Incorrect rope selection will always result in a shorter service life of the rope.

### Intended Use

Ropes as a machine or part of a machine may only be used for their predetermined purpose. All verope® special wire ropes may only be used for lifting purposes as part of hoists or load handling devices. Every use beyond is deemed to be incorrect and eliminates the manufacturer's liability.

Proper use includes, that the ropes may only be used in compliance with the relevant standards and specifications of the respective crane manufacturer. Special attention must be paid to the maximum safe working load and installation conditions (maximum bending radius, maximum deflection angle, maximum temperature, etc.).

An independent reduction of the safety factors specified by the machinery or by the user is inadmissible and, in the worst case scenario, a danger to life and physical condition and additionally may result in high damage costs.

verope® special wire ropes and their end terminations may only be installed in a system approved for this purpose. The system has to be adapted in its dimensions (e.g. openings, bolts, etc.) to the respective final rope termination. If there is any doubt, verope® AG has to be consulted.

The user must ensure adequate inspection and maintenance of the ropes. In the event of any doubt to the ability of verope® special wire ropes to practice its intended use, verope® AG must be consulted.

If there are laws or regulations available in the user country that go beyond the generally known standards and regulations, they must be followed.

Pierre Verreet, CEO

verope® AG | St. Antons Gasse 4a | CH-6300 Zug ZG – Switzerland  
Tel: + 41 (0) 41 72 80 880 | www.verope.com

# CONTENIDO

<b>Notas generales</b>	<b>Página 4</b>	Removal of protruding wires	Page 15
Unloading, transporting and storing reels	Página 4	External corrosion	Page 16
Correct storage of wire rope reels	Página 4	Diameter reduction	Page 16
Handling the rope during unwinding and rewinding operations	Página 5	Inspection report	Page 17
How to cut a steel wire rope	Página 7	<b>Different rope failures</b>	<b>Page 19</b>
Types of rope end connections and rope ends	Página 7	<b>Installation instructions</b>	<b>Page 20</b>
		General installation instructions	Page 20
<b>Re-lubrication of special wire ropes</b>	<b>Página 8</b>	<b>Installation instructions on deck cranes</b>	<b>Page 22</b>
Types of lubricants	Página 8	The installation process	Page 22
Quantity and frequency of re-lubrication	Página 8	Typical example of a deck crane	Page 22
Preparing the rope for re-lubrication	Página 8	Installation of the new rope using the old rope or a thinner rope	Page 23
Application of the re-lubricant and the different methods	Página 9	Fastening of the rope end connection at the fixed point	Page 23
<b>The correct rope inspection</b>	<b>Página 10</b>	Incorporation of the new special wire rope	Page 23
Why rope inspection?	Página 10	Untwisting of installed ropes	Page 24
General visual inspection/ Daily visual inspection	Página 10	<b>Installation instructions on mobile cranes</b>	<b>Page 24</b>
Regular inspection	Página 10	Pulling on the new rope	Page 24
Tools required for the rope inspection	Página 11	Winding the rope onto the drum	Page 25
Measuring the diameter of a rope	Página 11	Rope reeving and rope twisting	Page 25
How to measure the lay length of a rope	Página 12	Twisting of the hook block	Page 26
Measurement of rope sheave groove profiles	Página 12	Untwisting of rotation resistant ropes	Page 26
Groove depth	Página 14	<b>Important information</b>	<b>Page 28</b>
Material hardness	Página 14		
Wire breaks on the rope surface	Página 14		



# GENERAL NOTES

## UNLOADING, TRANSPORTING AND STORING REELS

The handling of wire rope reels requires a certain degree of caution. The reel should therefore be unloaded from the loading area either by means of a fork lift, where the reel is lifted by means of a sufficiently dimensioned shaft as attachment points for the forks,

or by means of an overhead crane as described in the picture below. The wound reel of wire rope should be moved as described before. Reels can easily be knocked over by the forklift which may damage both the reel and wire rope, so it is not advisable to do so.

note

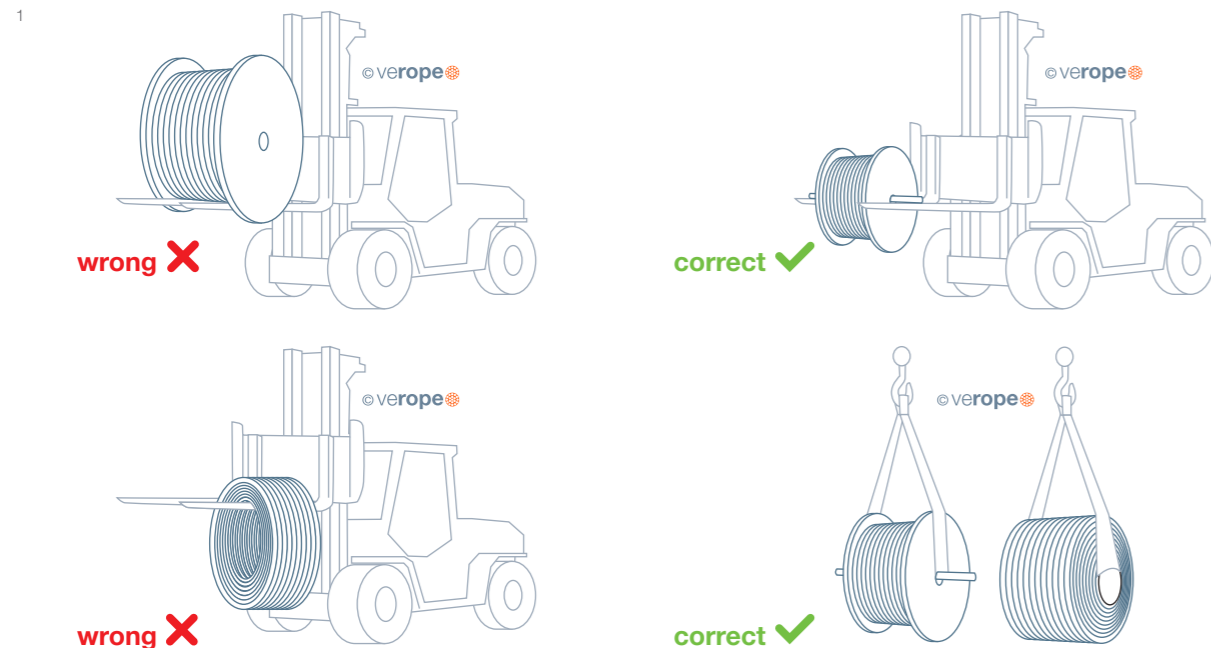

## CORRECT STORAGE OF WIRE ROPE REELS

After unloading, the reel must be stored in the correct manner. It is important that the reel is always supported with a pallet to protect it from soil moisture. In addition, storage should take place in a covered area where the rope is protected from the weather. In all situations the reel must be protected from direct rain and sunlight. Even if the storage is only short-lived, the measures described above must be applied.

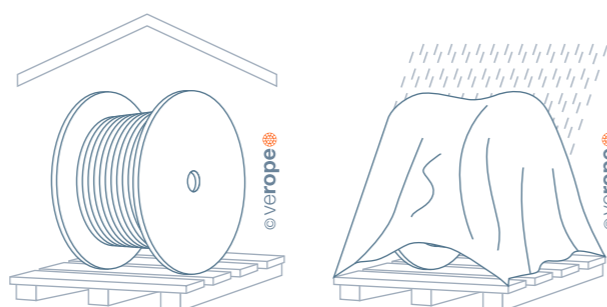

## HANDLING THE ROPE DURING UNWINDING AND REWINDING OPERATIONS

Suitable devices are required to spool the defined rope length onto a drum or to bring the rope into the reeving system.

Thus, turntables or reel stands, as shown in the picture, provide optimal conditions for installing the rope.

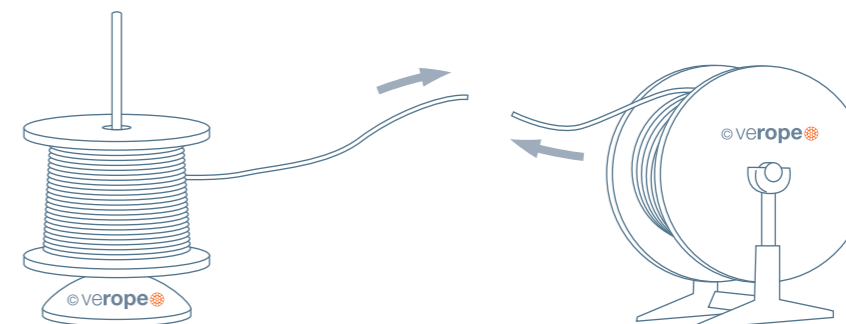

For ropes that are wound onto drums, it is also important that the correct winding direction is maintained and that the rope is installed with a pre-tension. If the rope leaves the reel from the top it must also be wound onto the drum from the top. Always reel from top to top or bottom to bottom otherwise the result will be

rope damage which can make the rope unusable. The pre-tensioning of the rope to be installed ensures rope safety and a ideal spooling pattern on the drum. This pre-tensioning is obligatory, as the rope can be easily destroyed during the first hoist operation with load if it is spooled loosely onto the drum.

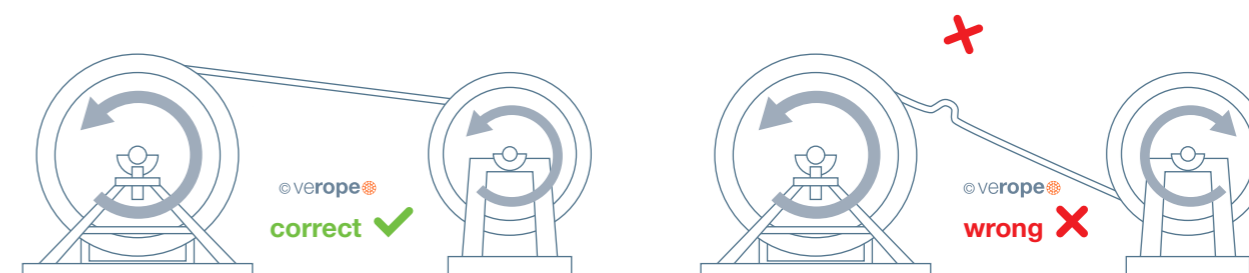

According to the standard, a pretension equivalent to at least 2.5 % to 5 % of the minimum breaking load should be applied. Often these values cannot be achieved with the given devices, therefore the motto is here

„the more the better“. The following figure shows the correct winding direction and a winding process in which the reel is braked.

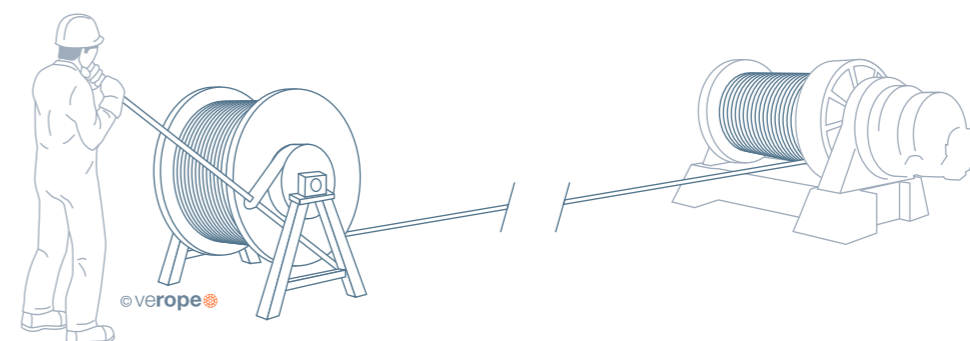





The following picture shows correct and incorrect general rope unwinding methods.

note  
2,8

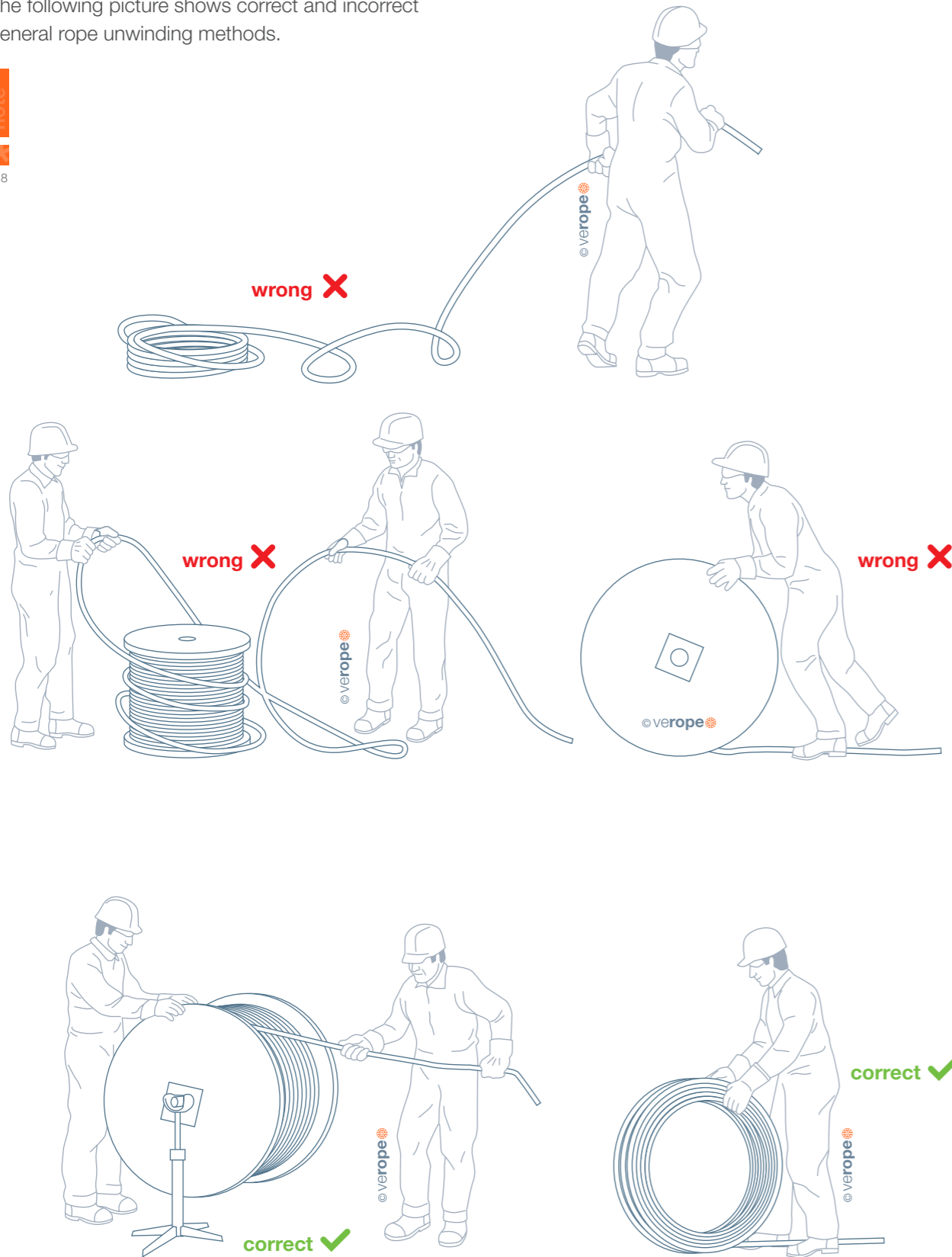

## HOW TO CUT A STEEL WIRE ROPE

Steel wire ropes consist of many strands closed in a helix and due to this structure ropes must be secured against untwisting. This is usually ensured by welding the ends together or by attaching a suitable end connection. If the rope is to be shortened from its original

length, the rope must be secured on both sides of the desired cutting point. The pictures below show the use of seizing wire, which must be applied in order to secure. The length of the joint is defined as follows:

$$L = 2 \times \text{rope diameter } d$$

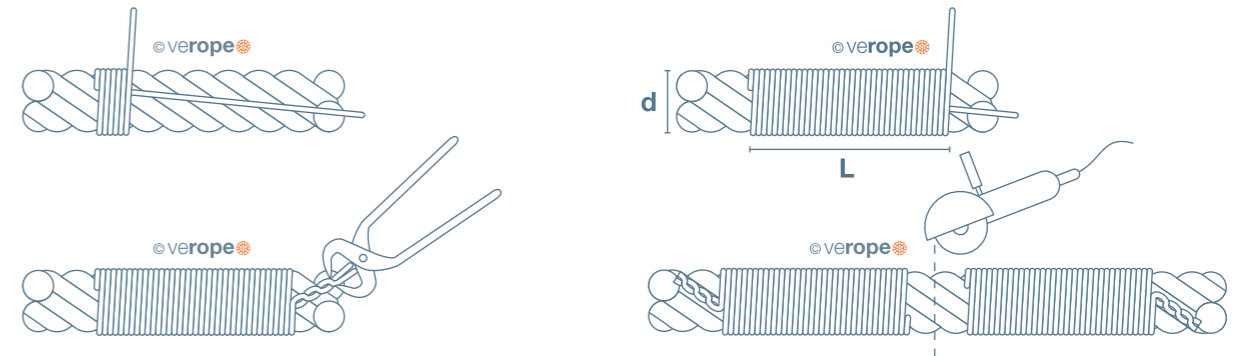

## TYPES OF ROPE END CONNECTIONS AND ROPE ENDS

The connections listed below are commonly used in the rope industry. The selection of the correct end connection depends on the type of rope and application.

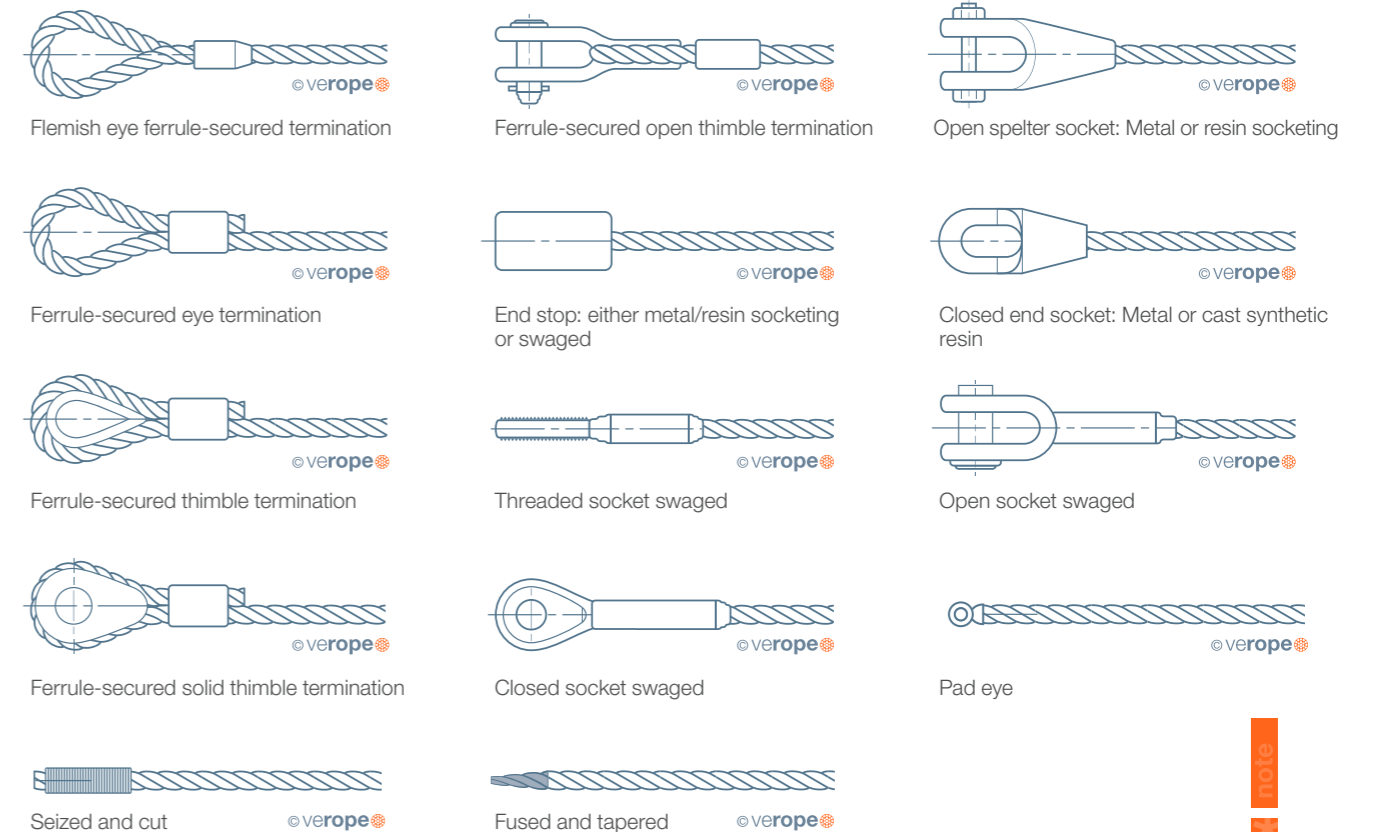

note  
3,4



# RE-LUBRICATION OF SPECIAL WIRE ROPES

## TYPES OF LUBRICANTS

verope® generally uses two types of lubricants: wax- and oil-based lubricants. The selection of the basic lubricant depends on the application, rope type and environment.

There are also lubricants that are used in areas that have special requirements such as water solubility, drip resistance or nature conservation guidelines. The variety of lubricants is as diverse as the number of different applications.

In order to increase rope service life and protect the rope interior, the lubricant film on the rope surface must remain constant. Lubricant is usually lost during operation and must be re-applied with regular re-lubrication.

The lubricant used for re-lubrication needs to be compatible with the lubricant used during production.

If you are uncertain, which lubricant can be used for re-lubrication, we are happy to assist you

## QUANTITY AND FREQUENCY OF RE-LUBRICATION

In general, we recommend that the rope should be relubricated 10 times over its entire service life. For applications with a comparable short service life (e.g. due to high and rapid wear), re-lubrication must be carried out as required.

The amount of re-lubricant to be applied can be determined using the following equation:

$$\frac{\text{Rope weight } \frac{\text{kg}}{\text{m}} \times \text{Rope length m}}{100} = \text{Amount of lubricant kg}$$

## PREPARING THE ROPE FOR RE-LUBRICATION

The rope must be prepared so that the re-lubrication and the newly applied preservative fulfil its full function. Applying the new lubricant without removing the existing lubrication, which is often dried out and has lost its lubricating effect, defeats the purpose of the operation. In addition, a rope that is free of surface dirt should be inspected more closely to detect possible defects.

There are several ways to remove the existing lubricant from the rope surface. One way is by using a cleaning system which removes the contamination from the rope surface by means of rotation.

Another conventional method to remove the lubricant from the rope surface is by the use of steel wire brushes. The lubricant is simply scraped off the rope surface by relative movements. The more lubricant removed from the surface the better the effect of the new lubricant.

This method requires a great deal of force and is time-consuming, depending on the rope length. However, if no other method is available, this procedure is very effective.

## APPLICATION OF THE RE-LUBRICANT AND THE DIFFERENT METHODS

After the old lubricant has been removed from the rope surface, the new lubricant can be applied. Various methods and procedures exist.

There are several companies that offer complete re-lubrication solutions. In the first method, the principle differs only in appearance. The rope is enclosed by a sleeve (often made of cast iron). In the sleeve there is a cavity into which the lubricant is forced under high pressure. Excess lubricant is removed at the end by means of a wiper.

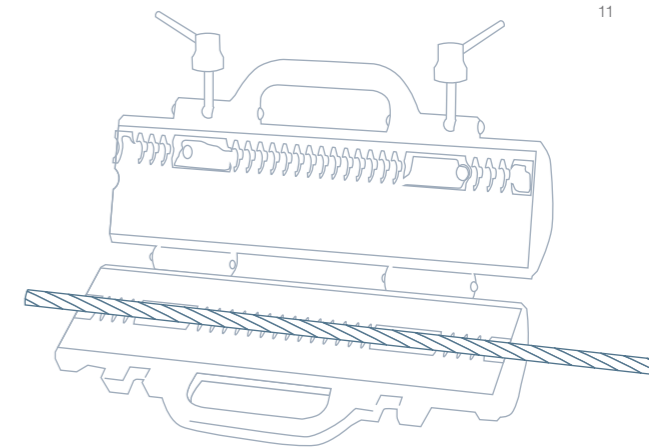
note  
11

Many applications, such as container gantry cranes, have automatic lubricant spraying devices, that continuously re-grease the rope. This type of re-lubrication occurs when, for reasons of time or cost, the system cannot be shut down or the need of lubricant is increased. This device can easily be retrofitted by companies offering this service.

Another and most cost-effective method is manual application. Here, either atomizer systems using compressed air or simple tools such as brushes or rags can be used. With this method, care must be taken to

ensure uniform application. Both, too much and too less lubricant, is counterproductive, an even film of lubricant is the best way to achieve the best results. For diameter ranges between 10 mm - 30 mm there are lubricants in spray cans for post-conservation.

The practical aerosol cans allow an even mist to settle on the rope. The propellant gas in the can flies away and leaves pure lubricant on the rope. verope® also offers a lubricant in aerosol cans for verope® special wire ropes. The verolube® aerosol cans are available upon request.



### Influence of the re-lubrication on the lifetime of a rope

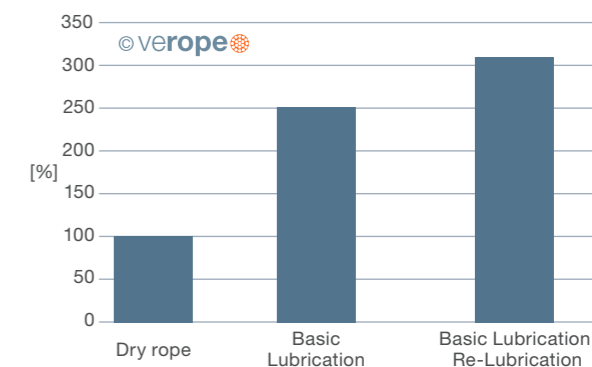



# THE CORRECT ROPE INSPECTION

note  
4,13

## WHY ROPE INSPECTION?

Ropes in rope drives are open gears which are exposed to external influences but also have common signs of wear. Above all however, the service life of a rope is limited. Once the rope has reached its discard criterion, it has also reached the end of its service life. The rope's discard state must be detected early enough to avoid accidents such as a rope break. This detection requires regular rope inspections, which document the percentage of rope life left before it is ready to be discarded.

### A meaningful rope inspection should consider the following points:

- General visual inspection (places requiring increased attention)
- Diameter measurement with a suitable tool and at different strategic positions
- Measurement of rope lay length
- Evaluation of degree of corrosion, if any
- Inspection and classification of the most frequently stressed rope zone for wire breaks
- Measurement of the groove diameters located in the rope drive
- Evaluation of the amount of lubricant on the rope surface.

Such inspections must be carried out on a regular basis. The intervals of the different tasks mentioned above may vary. A visual inspection should be carried out daily, but the diameter for example should be measured monthly or quarterly, depending on the load and frequency of use.

## GENERAL VISUAL INSPECTION / DAILY VISUAL INSPECTION

With a general visual inspection, obvious damage such as cracked strands or errors in the reeving should be detected at an early stage and, if possible, repaired before the start of operation. In this case, places near

the end connection or places that could get into contact with the crane must be inspected with increased attention. This inspection should be carried out carefully by the crane operator.

## REGULAR INSPECTION

The regular inspection must be carried out by a competent person. The complete crane system should be monitored and maintained.

### Practical examples

- Measurements to be carried out on a quarterly basis: Diameter and lay length
- Annual measurements: groove size, sheave depth, hardness of sheaves and drum (optional)

## TOOLS REQUIRED FOR THE ROPE INSPECTION

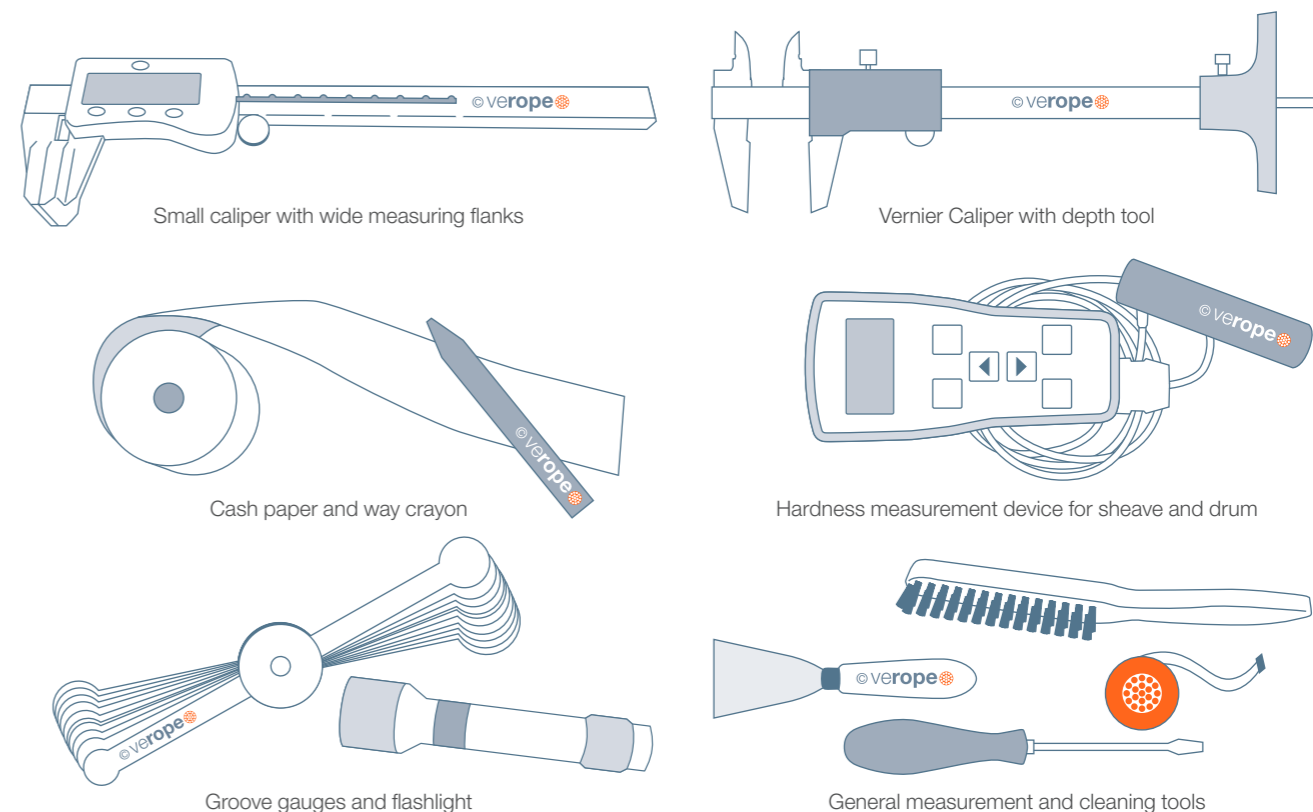

## MEASURING THE DIAMETER OF A ROPE

Measuring the diameter of a wire rope during operation provides information on the wear and the diameter reduction. However, an increased diameter may also occur to a structural change. The diameter of the rope should always be determined with the aid of suitable measurement equipment. Small calipers with wider measurement flanks are advantageous here. The following pictures display suitable measuring equipment.

A rope must always be measured at its widest point, i.e. from strand crown to strand crown. A complete measurement consists of two measurements in the X-direction and two measurements in the Y-direction, each approximately 1 m apart. The resulting average of the values describes the current rope diameter.

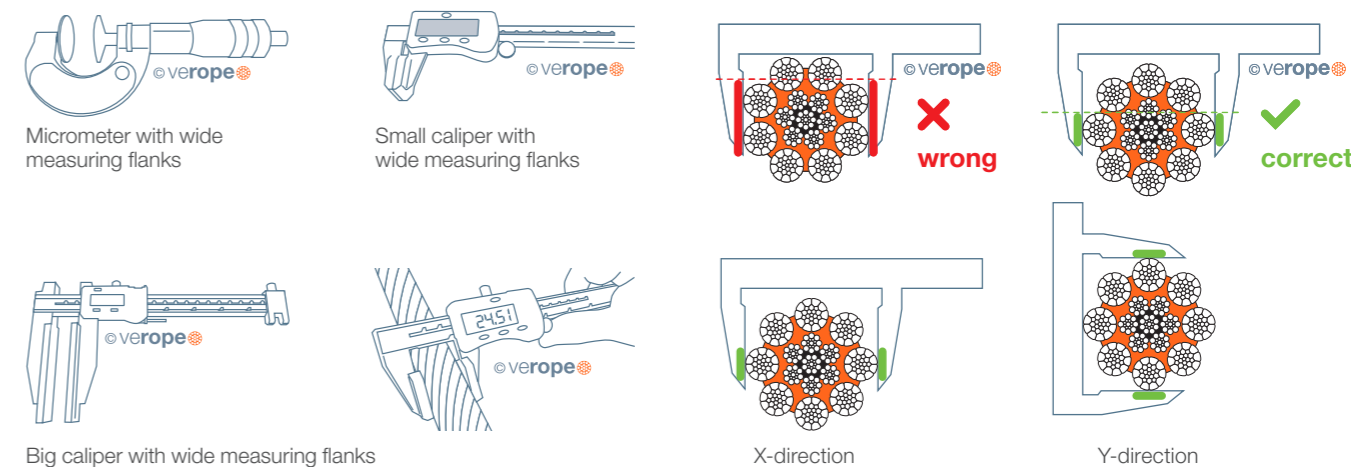





## HOW TO MEASURE THE LAY LENGTH OF A ROPE

An indication of whether a rope has been twisted by force or has generally undergone an unnatural twist can be found in a resulting change of lay length. In order to measure the lay length, the following utensils are required. A negative of the rope surface is created with the help of a cash register roller and a wax crayon. In this process, a cash register paper must be placed on the rope surface while a wax crayon is moved across with downwards pressure. As a result, there is an impression of the rope strands on the paper.

In order to determine the lay length of the rope a certain number of impressions must be counted. Here the number of outer strands is decisive (in the picture above there are 8 outer strands). The distance from the beginning and end point gives the lay length in mm. It is recommended to count at least three measurements and divide the total length by three parts in order to reduce measuring errors (see picture).

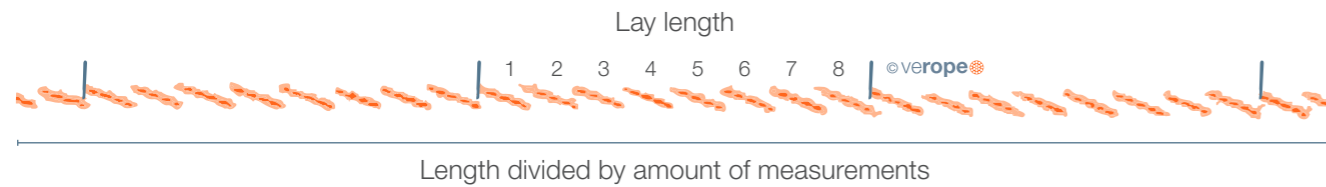

## MEASUREMENT OF ROPE SHEAVE GROOVE PROFILES

A rope inspection includes not only the inspection of the rope itself, but also of the sheaves in which the rope runs. Special measuring equipment is required to measure the groove diameter: Groove gauges and a flashlight.

Such groove gauges are available upon request from verope®. The values indicated on the gauge are actual values and not, as is sometimes the case, target values. The flashlight serves as an aid to determine the exact measurement. Here the gauge in the groove is illuminated from behind. If light shines through on the sides between the gauge and the sheave, this indicates, that the used gauge is too large. If there is no light visible at the complete radius of the gauge, the correct groove size corresponds to the gauge size used.

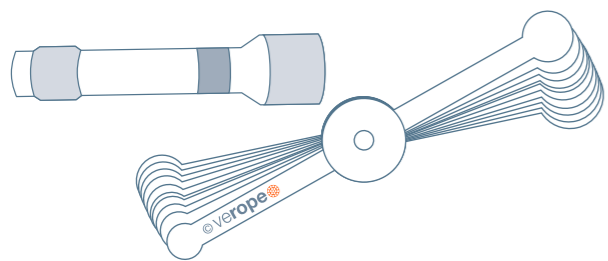

The following pictures show the different scenarios that can occur during measurement.

R = groove radius d = Nominal rope diameter

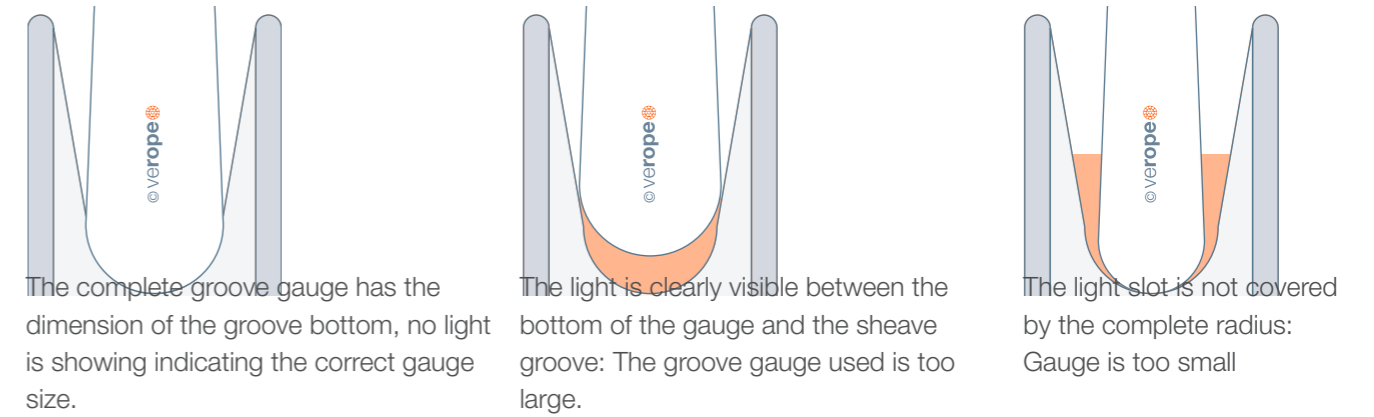

According to the standard, the groove radius R should be between 0.525 x d and 0.550 x d, the optimum groove radius is 0.5375 x d.

### Example:

For a rope with a nominal diameter of 22 mm, the following values apply:

- Minimum allowed groove diameter: 23.10 mm
- Optimum groove diameter: 23.66 mm
- Maximum allowed groove diameter: 24.20 mm

The following diagram shows the effect on rope service life with different groove size ratios.

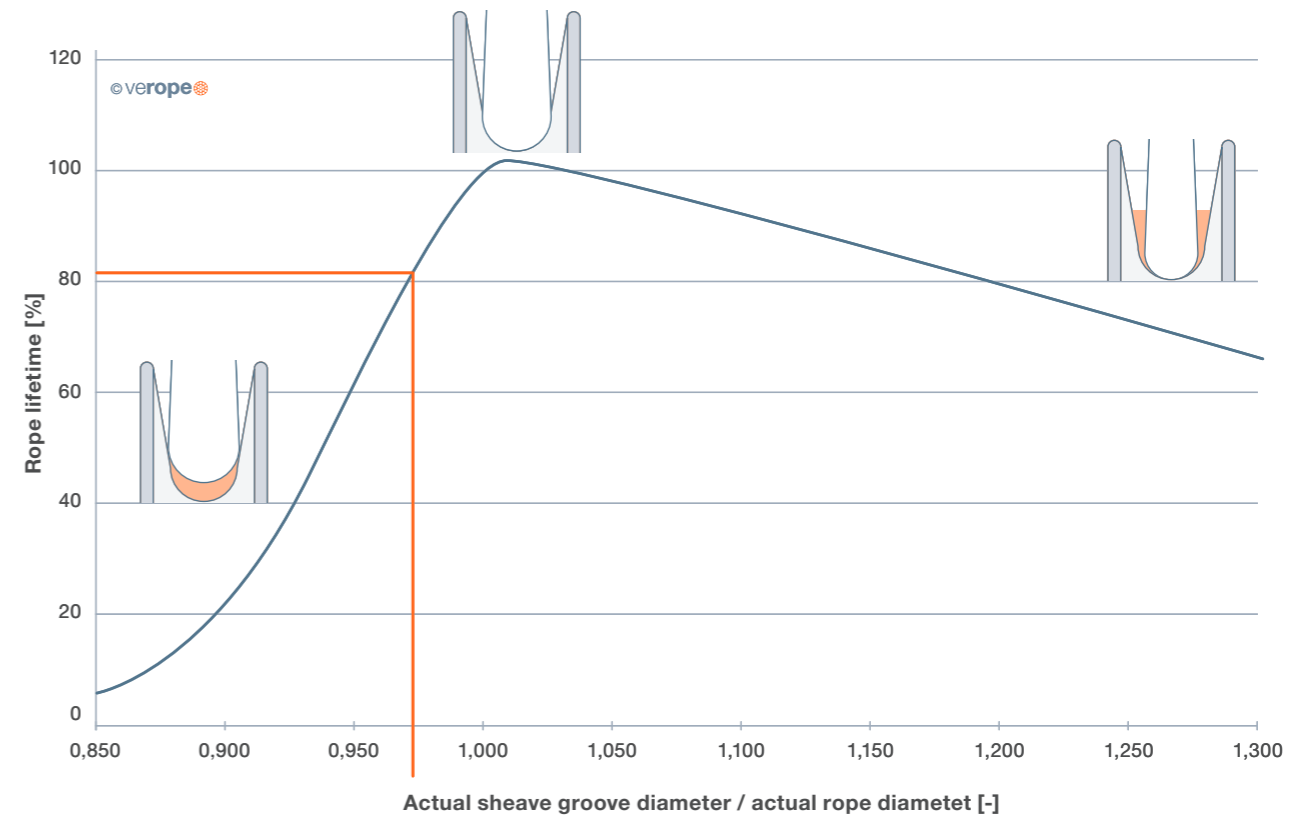

### Example:

Rope with an actual diameter of 22,66 mm working in a groove with an actual diameter of 22 mm experiences a service life loss of approx. 20%.

$$\frac{22.00 \text{ mm}}{22.66 \text{ mm}} = 0.97$$



### GROOVE DEPTH

According to ISO 16625, the groove depth should be no greater than 1.5 times the rope diameter and in addition, the bottom of the groove must be circular. The maximum permissible depth until the sheave has to be replaced due to wear must be specified by or obtained from the sheave manufacturer. This value must be observed at all times as disregarding it can result in serious accidents as a result of material failure.



### MATERIAL HARDNESS

Ropes usually have different strengths, tensile grades such as 1770 N/mm<sup>2</sup>, 1960 N/mm<sup>2</sup> or 2160 N/mm<sup>2</sup> are common. The diagram to the right shows the respective degree of hardness in HV (Vickers Hardness) for the corresponding strength class. The hardness of the sheaves and drum should be between 300 - 350 HV. This is due to the fact that rope sheaves that are too soft absorb the pure wear of the system and thus the discard criterion of the rope is more difficult to detect. If the used rope sheave or rope drum has a higher hardness value, this does no harm to the system, but involves higher hardening costs.

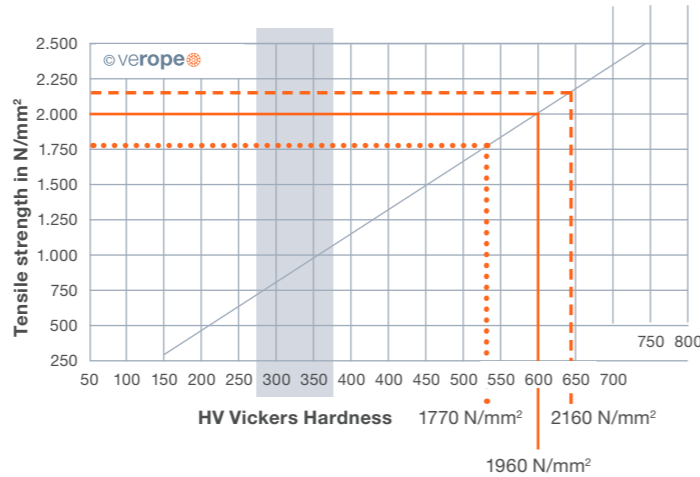

### REMOVAL OF PROTRUDING WIRES

Some wire breaks may cause the wire to protrude from the rope. This wire can damage neighboring wires when it runs over the sheave again causing secondary wire breaks. With the help of pliers and continuous back and forth bending of the protruding wire, it can be removed and is no longer a danger to neighboring wires.

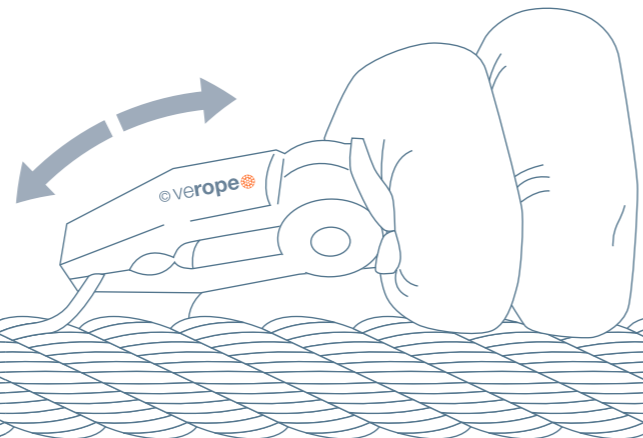

### WIRE BREAKS ON THE ROPE SURFACE

Wire breaks on the rope surface are caused by bending stress on the rope when running over sheaves. The number of wire breaks over a defined length must not exceed a certain number corresponding to its design and subsequently to the RCN (Rope Category

Number), otherwise it must be discarded immediately. Whereas the distribution of wire breaks does not seem to follow a certain pattern, the shown standard cannot be applied to wire breaks caused by contact with the steel structure.

### ROTATION-RESISTANT SPECIAL WIRE ROPES

verope® special wire rope construction	Number of outer strands	Number of load-bearing wires in the outer strands	Rope category RCN according to ISO 4309	Stripping wire breaking number according to ISO 4309 <sup>1</sup>			
				For applicable rope ranges see footnote <sup>2</sup>		For applicable rope ranges see footnotes <sup>3,4</sup>	
				over a length of		over a length of	
				6 x d <sup>5</sup>	30 x d <sup>5</sup>	6 x d <sup>5</sup>	30 x d <sup>5</sup>
vero 4	4	144	22	2	4	4	8
verotop XP	16	96	23-1	2	4	4	8
verotop verotop S verotop S+ verotop E	16	112	23-2	3	5	5	10
verotop P	18	126	23-3	3	5	6	11

### NON-ROTATION RESISTANT SPECIAL WIRE ROPES

verope® special wire rope construction	Nominal rope diameter d (mm) <sup>7</sup>	Number of outer strands	Number of load-bearing wires in the outer strands	Rope category RCN according to ISO 4309	Stripping wire breaking number according to ISO 4309 <sup>1</sup>						
					For applicable rope ranges see footnote <sup>2</sup>			For applicable rope ranges see footnotes <sup>3,4</sup>			
					Classes M1 to M4 or class unknown <sup>6</sup>		All classes M1 to M8				
					Cross stroke	Equal stroke	Cross and equal stroke				
				over a length of		over a length of					
						6 x d <sup>5</sup>	30 x d <sup>5</sup>	6 x d <sup>5</sup>	30 x d <sup>5</sup>	6 x d <sup>5</sup>	30 x d <sup>5</sup>
verostar 8	6 to 7	8	136	3	4	8	2	4	8	16	
veropro 8	8 to 42	8	208	9	9	18	4	9	18	36	
veropro 8 RS	43 to 48	8	248	11	10	21	5	10	20	42	
verosteel 8	larger 48	8	288	13	12	24	6	12	24	48	
veropower 8	up to 40	8	208	9	9	18	4	9	18	36	
	41 to 46	8	248	11	10	21	5	10	20	42	
	larger 46	8	288	13	12	24	6	12	24	48	
verotech 10	larger 10	10	260	11	10	21	5	10	20	42	
veropro 10	larger 49	10	310	-	12	24	6	12	24	49	
verotech 10	6 to 9,5	9	153	4	5	10	2	5	10	20	
	10 to 16	9	234	10	10	19	5	10	20	38	

**Note: 1)** Please note that a counted broken wire always has two ends. **2)** Shall be applied exclusively to those sections of rope running only over steel sheaves and/or spooling on a single-layer drum. For single layer spooling ordinary lay ropes have to be used. The wire breaks are randomly distributed. **3)** Shall be applied exclusively to those sections of rope spooling on a multi-layer drum. **4)** The values are valid only in conjunction with footnote 3 and apply to deterioration that occurs at the cross-over zones and interference between wraps due to fleet angle effects. Note: These values do not apply to those sections of rope running only over sheaves but do not spool on the multi-layer drum! **5)** d = nominal rope diameter **6)** Twice the number of broken wires listed may be applied to ropes on mechanisms whose classification is known to be M5 to M8. **7)** Other rope diameters on request.





## EXTERNAL CORROSION

Ropes in particular environments or with a high lifetime start to corrode. The standard distinguishes different corroding levels.

The following pictures shows the different levels according to ISO 4309.

### Guideline to rate the intensity of the corrosion



1. Beginning of surface oxidation, can be wiped clean, superficial – Rating: 0% towards discard



2. Wires rough to touch, general surface oxidation – Rating: 20% towards discard



3. Surface of wire now greatly affected by oxidation – Rating: 60% towards discard



4. Surface heavily pitted and wires quite slack, gaps between wires – Discard immediately

## DIAMETER REDUCTION

The rope diameter of a working rope is constantly reduced over its entire service life. This reduction of the diameter is caused by abrasion and wear and is evaluated according to the following table and classified up to the point of discard maturity.

uated according to the following table and classified up to the point of discard maturity.

Rope type		Uniform decrease in diameter (expressed as percentage of nominal diameter)	Severity rating		
			Description	%	
© verope Single-layer rope with steel core or parallel-closed rope	verostar 8 veropro 8 veropro 8 RS veropower 8 veropro 10 verotech 10 verosteel 8	Less than 3.5 % 3.5 % and over but less than 4.5 % 4.5 % and over but less than 5.5 % 5.5 % and over but less than 6.5 % 6.5 % and over but less than 7.5 % 7.5 % and over	– slight medium high very high Discard	0 20 40 60 80 100	
	Rotation-resistant rope	verotop verotop S verotop E verotop P verotop XP vero 4	Less than 1 % 1 % and over but less than 2 % 2 % and over but less than 3 % 3 % and over but less than 4 % 4 % and over but less than 5 % 5 % and over	– slight medium high very high Discard	0 20 40 60 80 100

The following formula is used to determine the diameter reduction.

$$\Delta d = \left[ \frac{d_{ref} - d_m}{d} \right] \times 100 \%$$

Example: A single layer steel core rope with a nominal diameter of 22.00 mm has a reference diameter of 22.80 mm as in calculation example and a measured diameter of 21.90 mm.

To proof:  $\left[ \frac{22.80 - 21.90}{22} \right] \times 100 \% = 4,1 \%$

The rope has reached a discard maturity of 20 % by means of diameter reduction

## INSPECTION REPORT

The inspection report of DIN ISO 4309 provides helpful support.

This report lists all relevant points of a structured rope inspection.

Crane reference: _____						Rope application: _____					
Rope details: _____						Direction an type of lay <sup>a</sup> : (Right): sZ ZZ Z / (Left): zS sS S					
Brand name (if known): _____						Permissible number of visible broken outers wires: ____ 6 d ____ 30 d					
Nominal diameter (mm): _____						Reference diameter (mm): _____					
Construction: _____						Permissible decrease in diameter from reference diameter (mm): _____					
Core <sup>a</sup> : ____ IWRC ____ FC ____ WSC											
Wire finish <sup>a</sup> : ____ Uncoated ____ Zinc/Gal.											
Date installed: _____						Date discarded: _____					
Visible broken outer wires		Diameter				Korrosion	Damage and/or deformation		Position in rope	Overall assessment i.e. combined severity rating <sup>b</sup> at position indicated	
Number in length of	Severity rating <sup>b</sup>	Measured diameter	Actual decrease from reference	Severity rating <sup>b</sup>	Severity rating <sup>b</sup>	Severity rating <sup>b</sup>	Nature				
6 d	30 d	6 d	30 d	mm	mm						
Other observations/comments:											
Performance to date (cycles, hours, days, months, etc.): _____						Date of inspection: _____					
Name (print) of competent person: _____						Name (signature): _____					

<sup>a</sup> Tick as applicable.

<sup>b</sup> Describe degree of deterioration as: slight, medium, high, very high or discard.







Protruded IWRC of rotation resistant rope



Kink



# INSTALLATION INSTRUCTIONS

## GENERAL INSTALLATION INSTRUCTIONS

In time, all steel wire ropes will need to be replaced due to their limited service life, which is normally significantly shorter than the service life of the application. The installation process differs between the different applications on which the rope is installed. However, regardless of the type of application, the following instructions should be followed:

- Avoid counter-bending, pay attention to the direction of feed and return spooling.
- Maximize distance between first incoming sheave and rope reel (>6 m)
- Always install a swivel between the pull-in rope and the new rope.

If these points are followed, some damage to the rope and consequential damage can be avoided in advance.

### Rope installation:

The rope installation must be carried out with the necessary care and work safety when installing a rope.

Before installing the rope, the rope construction and the direction of lay with the the winch drum and the rope system should be analyzed.

The condition and dimensions of the rope grooves in rums and rope sheaves must be checked to ensure that they comply with the specifications.

If the new rope is used with an auxiliary rope of lower diameter, a non-rotating, rope design or a synthetic rope construction can be selected.

Will the new rope was pulled in with the old rope, the ends should be connected with a swivel. Twists from the old rope can occur during the pulling process and will eliminated by the swivel.

note  
5,6,7,9

### New rope and old rope with a same diameter

Chinese finger

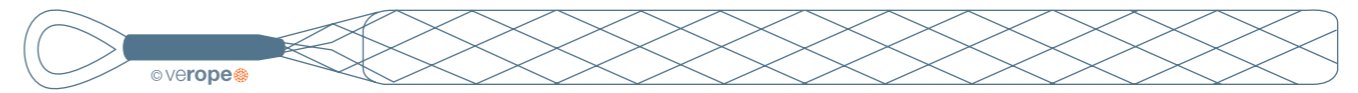

Connecting rope with rope clamps according to EN 13411-5

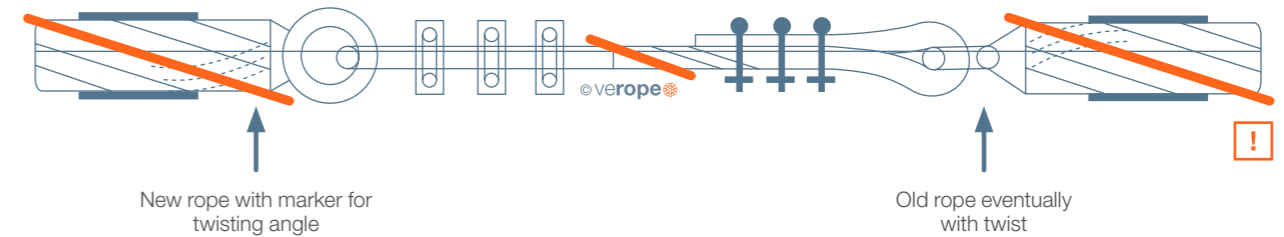

Seizing minimum  $2 \times d$  each side

### Pulling rope with smaller diameter

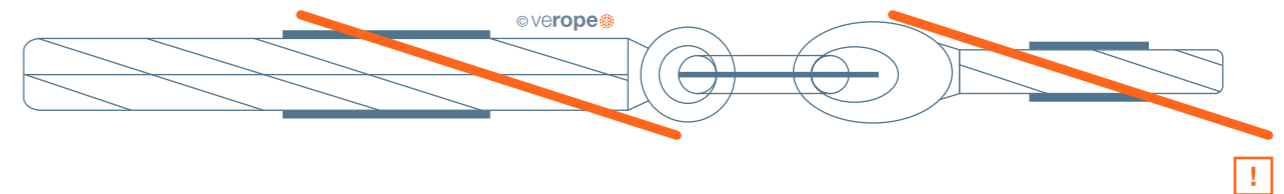

**! ONLY ROPES WITH SAME LAY DIRECTION !**

Before each rope change (preferably when ordering a new rope), all rope sheaves must be checked for suitable groove profiles, negative impressions and ease of movement. The groove geometry and the general condition of the rope drum must also be checked.

note  
10





# INSTALLATION INSTRUCTIONS ON DECK CRANES

## THE INSTALLATION PROCESS

The most advantageous way to install a steel wire rope varies from crane to crane. In all cases a method should be chosen that (at a reasonable cost) constitutes the lowest possible risk of twist or other damages to the rope. When unwinding the rope from the supply reel, the supply reel must be mounted in a way that allows its rotation.

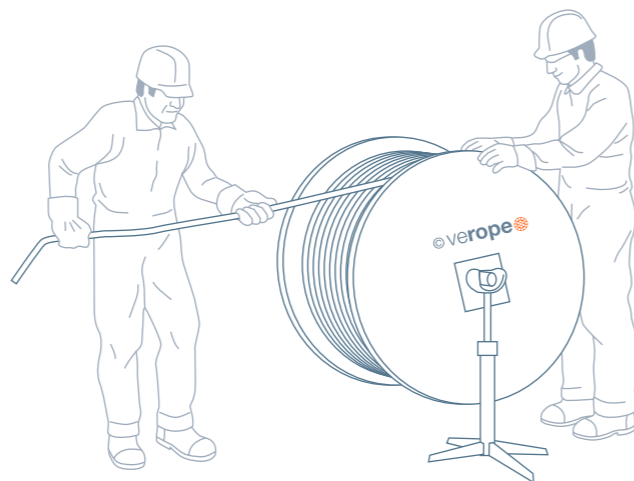

The removal of the new rope from a stationary pulley or non-rotating reel leads to rope twist and the rope can already be destroyed during installation.

For some cranes it may be advisable to lay down the old rope first and then install the new rope. For other cranes, especially larger cranes, it may be better to attach the new rope to the old rope and pull it in.

Another option is to use a thinner rope as the pull-in rope, with which the actual wire rope is later pulled into the system. This method is often used on new equipment. In any case, it should be carefully considered whether the wire rope should be pulled through the entire reeving system or whether it should first be wound from the reel onto the drum and then pulled into the system.

## TYPICAL EXAMPLE OF A DECK CRANE

Below is an example of a typical deck crane in which the rope is pulled from the rope reel over the sheaves into the reeving and wound onto the rope drum. It must be ensured that the rope surface remains clean and that no sand or dirt adheres to the rope lubricant. A dirty rope can damage its wires when running over the sheaves and significantly reduce the effectiveness of the lubricant.

## INSTALLATION OF THE NEW ROPE USING THE OLD ROPE OR A THINNER ROPE

If the new rope is pulled from the old rope or from a thinner rope, it must be ensured that the connection between the ropes is absolutely secure. It must also be ensured that the thinner rope cannot rotate/twist. For example, rotation-free ropes must be pulled in with the same rotation-free ropes or rotation-resistant 4-strand ropes. When installing non-rotation-resistant ropes, it must at least be ensured that new and old ropes have the same lay direction. In all cases it is helpful to install a small rope swivel between the rope ends in order to remove any possible twist.

If the new rope is pulled in with the help of the used rope, the two rope ends are often blocked. Such a connection can transfer the twist of the old rope which is in the system, into the new rope. This type of installation can cause extreme damage to the new rope even before it has been put into service for the first time. There are even more reasons why this procedure is very problematic: When welded mounting eyes are used, they can sometimes be overloaded and break due to the twist.

## FASTENING OF THE ROPE END CONNECTION AT THE FIXED POINT

After the rope has been pulled through the reeving, the rope end connection must be brought to the fixed point. With the aid of a chain hoist, the rope end connection can be pulled to the fixed point and secured there with a pin. Before fixing, the rope end connection can be aligned exactly to the fixed point using a steel rod. The rod should be attached to the rope with a short chain. Under no circumstances should the rope be gripped with a wrench or pliers, otherwise the outer wires will be damaged.

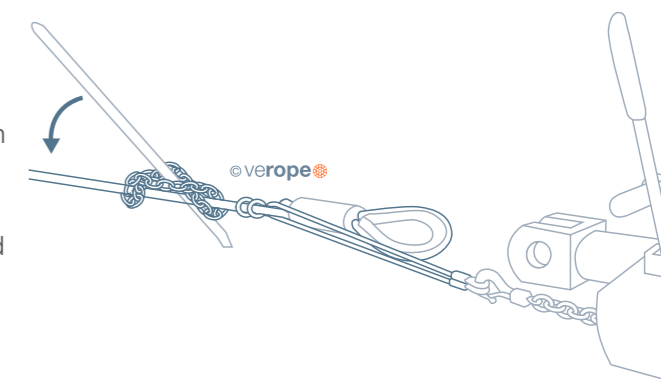

## INCORPORATION OF THE NEW SPECIAL WIRE ROPE

After the rope has been installed and before it fulfils its task, several runs of normal operation should be carried out under light load. The new rope should be "incorporated" so that the elements can settle and adapt to the actual operating conditions. It is regrettable that in practice the exact opposite of this recommendation is often made.





## UNTWISTING OF INSTALLED ROPES

If the bottom block is twisted due to overloads (rope not being worked in), uncontrolled working conditions (diagonal pull) or a poor installation conditions (worn rope sheaves), the rope twist can be removed at the fixed point.

However, the following procedure is only necessary if the rope strands touch each other. Rotation of the hook block by up to 90° can be regarded as normal. To do this, secure the rope at the end connection again with a chain hoist and loosen the fixed point.

When loosening the end connection, pay close attention to the direction in which it is twisted and how often. If necessary, the end connection can be further rotated several times in the rotating direction using the steel rod. Now the rope has to be fixed again at the fixed point and several cycles have to be carried out over the entire lifting height. As a rule, the twisting of the hook block has been significantly reduced however the process may have to be repeated again.

note

12



# INSTALLATION INSTRUCTIONS ON MOBILE CRANES

Many crane manufacturers work with special rope diameter tolerances. These must always be observed in order to achieve the best rope performance.

## PULLING ON THE NEW ROPE

If you unwind the rope from the supply reel, this must be mounted so that it is free to rotate. Pulling the new rope off a stationary pulley or non-rotating reel will cause twist in the rope and the rope may be destroyed during installation. It must also be ensured that the rope surface remains clean and that no sand or dirt adheres to the rope lubricant. A dirty rope will damage the wires if the rope runs over sheaves.

The following illustrations show the correct and wrong way to unwinding a rope.

Special care must be taken to ensure that the rope does not come into contact with parts of the steel structure or other fixed parts. The deflection angle between the supply reel and the first pulley of the crane must not exceed 2°.

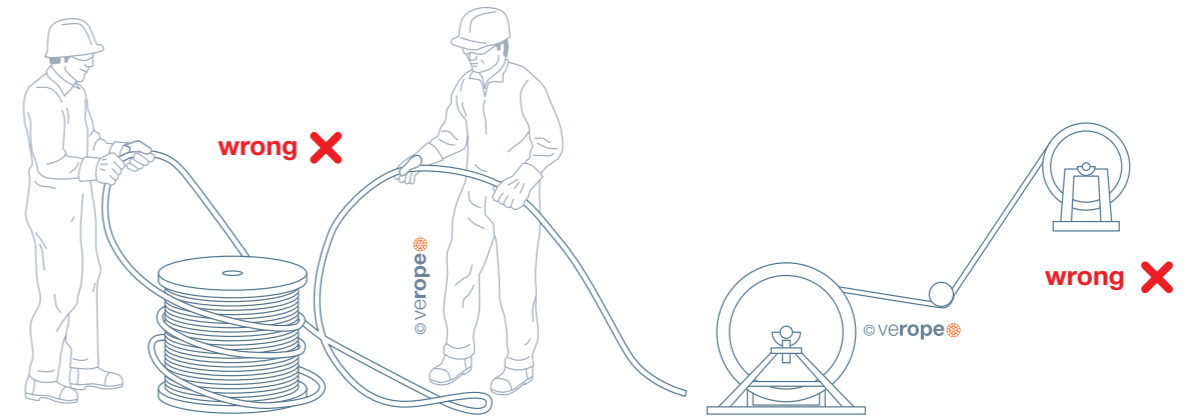
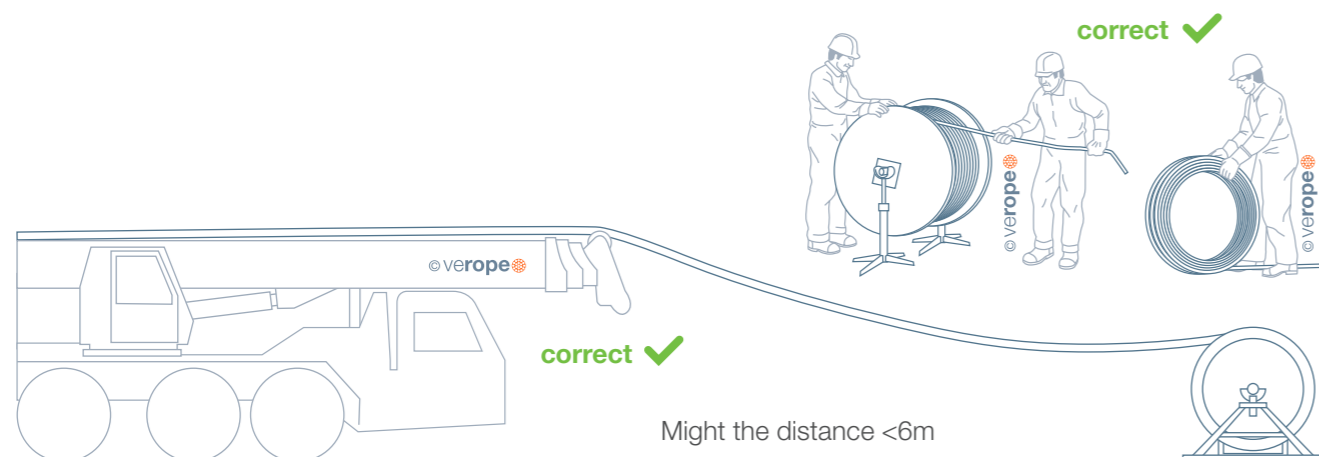

## WINDING THE ROPE ONTO THE DRUM

The notes on pages 4 to 6 should be followed for pre-tensioned rope installation. In particular, sufficient pre-tensioning of the rope on the drum must be given. Renew the pretension at regular intervals so that all rope layers can work together firmly as a “package”. This can be done in the field as follows:

Extend the boom so far or so high that you can unwind the entire rope length up to the 3 safety coils on the drum. Now lift a sufficient load so that the rope is wound from the first drum layer with sufficient pre-tension of at least 2.5% of the MBL or 10% of the SWL. This procedure is also necessary if the crane has only worked with a part of the total rope length. The start and stop movements of the drum cause the rope layers to shift to the lower layers and become loose. If the pre-tension of the rope on the drum is too low, the individual layers become loose and the rope strands that run up under tensile stress can pull themselves into the loose drum layer. This causes the rope to be crushed and severely damaged.

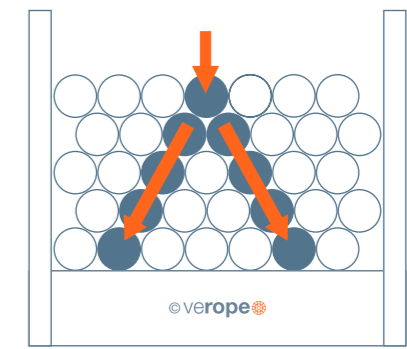

With pre-tension

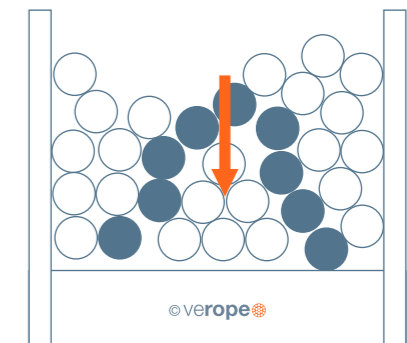

Without pre-tension

## ROPE REEVING AND ROPE TWISTING

During reeving might the balance of rope falls in the hook block. With an uneven ratio of the falls the hook block gets unequal and it occurs rope twist.

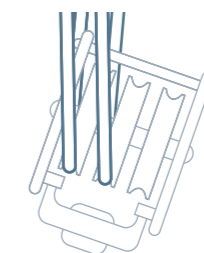

wrong X  
Unequal distribution of rope falls

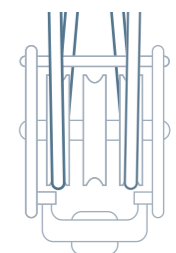

correct ✓  
Equal distribution of rope falls



## TWISTING OF THE HOOK BLOCK

There are several reasons why a hook block can twist:

1. The reeving of an odd number of falls is significantly less stable than the reeving of even falls. A 3-falls reeving is less stable than 4 falls.
2. Torque or twist has been applied to the rope during the installation of the rope. The maximum permissible deflection angle of max. 2° was often exceeded here.
3. The center of gravity of the load is not under the hook
4. Wrong or uneven attachment when using a double hook
5. Inclined or poorly balanced hook block
6. Worn or too narrow groove profiles of the rope sheaves
7. Poor rope lubrication or re-lubrication
8. Diagonal pull during load pick-up (>2°)
9. Incorrect reeving of the rope with deflection angles >2°.
10. Misalignment of the crane
11. Handling operation (always the same activities with high repetition rates)

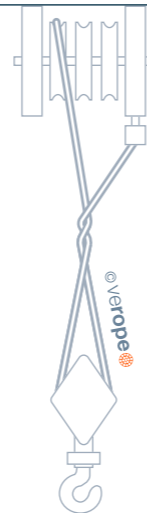

note

12

## UNTWISTING OF ROTATION RESISTANT ROPES

### Method A:

Detach the rope end from the fixed point. Turn the rope end in the opposite direction to the twisting of the hook block. When the hook block turns 1/2 turn, turn the end of the rope 180°. If the hook block rotates 3 full turns, turn the rope end 3 times around itself against the direction of rotation.

Reattach the rope end and guide the rope (without load) through the entire reeving by lifting the hook block. The twists are thus distributed over the entire rope length and significantly reduced. If the hook block still twists, this process must be repeated.

### Method B:

If rotation-resistant ropes such as verotop, verotop S or verotop E are used, a swivel can also be installed between the fixed point and the crane. This swivel absorbs possible twist or eliminates twist that is already in the rope. Once the twist is removed from the rope, the swivel can be blocked, completely removed or permanently installed. After the installation of a new rope, the rope should run several times under low load and at reduced speed with the boom fully extended. Repeat this procedure with increasing load and speed. This will allow the rope to adapt to the working conditions and all strands and wires will sit in a neutral position. Ideally, you should loosen the rope end again after the running-in time to release possible torque and twist that were built up during installation and running-in time

For questions, ambiguities or problems, please contact the customer service of the verope® technical department: [TCS@verope.com](mailto:TCS@verope.com)

## ADVERTISEMENT

# TECHNICAL BROCHURE

## verope® special wire ropes

The new and completely revised "Technical Brochure" is aimed at all customers, distributors and rope users. The brochure is available in German and English and provides useful information on the correct handling of special wire ropes by means of numerous graphics and tables.

Order here: [marketing@verope.com](mailto:marketing@verope.com)  
[www.verope.com](http://www.verope.com)





## INCORRECT SELECTION AND USE OF WIRE ROPES CAN BE DANGEROUS.

# IMPORTANT INFORMATION

note



With the following hints we would like to draw your attention to some essential points for correct selection, operation and maintenance of wire ropes. In addition to technical literature on wire ropes, national and international standards, the verope® team will be happy to assist you with all questions concerning wire ropes.

### Please contact us!

#### No. 1:

- Wire ropes must be properly transported, stored and maintained. Please note the relevant literature on these topics.

#### No. 2:

- Wire ropes must be checked for wear and damage before each use. This also applies to their end connections. Never use worn or damaged ropes or end connections!

#### No. 3:

- End connections assembled by verope® may not be changed by the customer. A swivel may only be used in combination with rotation-resistant rope constructions from verope® otherwise there is a danger of serious personal injury and property damage, possibly even death. If you are looking for a rotation-resistant rope construction please have a look at the verope® catalog or contact us for further information.

#### No. 4:

- Wire ropes and their end connections are not fatigue resistant endlessly and must therefore be controlled periodically for safe operation. Wire ropes and the end connections must be discarded before reaching a unsafe condition. Note please refer to the respective valid international or national standards (e.g. ISO 4309, EN 12385 and EN 13411) and the technical literature for expert inspection as well as for the correct determination

of the discard maturity of wire ropes and their end connections. During installation of ropes which are provided with an end connection it must be ensured that these have been carried out in accordance with the operating instructions at the designated place and can be installed in the correct position. For end connections, which can be dismantled, e.g. wedge end clamps, it is absolutely necessary to remove the rope or end connection according to manufacturer specifications. For questions, ambiguities or problems, please contact the customer service of the verope® technical department: TCS@verope.com

#### No. 5:

- Wire ropes must not be overloaded or subjected to shock loads.

#### No. 6:

- Under the influence of very high or very low temperatures, the rope behavior can change considerably. Please discuss this with our experts. See standard.

#### No. 7:

- The rope installation must be carried out or coordinated by at least one competent person. A competent person has sufficient knowledge and experience with rope installations and he knows risks and consequences when disregarding the correct procedure.

#### No. 8:

- During the winding process external influences like damages or twist must be avoided, to ensure a safe installation. A rope on a reel or on a ring is not free of tension and can cause personal injury in case of uncontrolled loosening. The rope must therefore be removed with the greatest care. The rope end on the reel or on the ring should be fixed during loosening and in the preferred bending direction guided. As soon as the end of the rope is reached, the speed of the rewinding operation shall be adjusted so that the end of the rope is not swinging around uncontrolled.

#### No. 9:

- It can be dangerous when being in the presence of running ropes and their application. Therefore, a suitable distance should be maintained. If the safe distance is not kept, it may result in heavy injuries.

#### No. 10:

- In the case of ropes installed by means of rope end connections the maximum payload of these must be taken into account.

#### No. 11:

- Ropes, that are not re-lubricated sufficiently or in time, tend to corrode internally and externally. The functional capability of the applications greatly reduce. On the other hand, too much or the wrong lubricant will cause the dirt to adhere, which causes the rope drive to wear out faster and obstructs the evaluation of possible discard criteria.

#### No. 12:

- Hitting rope falls in the free rope length is always a sign of unbalanced torque in the rope. The friction, generated between the rope, leads to damages on the rope. One method of untwisting the rope length is described on page 26. Occurred damages must be rated with the help of this brochure or according to official standards.

#### No. 13:

- The intervals between periodic inspections are depending on the condition, the intensity and the external influences of the application.

**For questions, ambiguities or problems, please contact the customer service of the verope® technical department: TCS@verope.com**

**PROTECT YOURSELF AND OTHERS!**  
**ROPE FAILURE CAN CAUSE SERIOUS DAMAGE TO PROPERTY, CAUSE INJURY OR DEATH!**

# WORLD OF VEROPE® BROCHURES



Order any of our brochures here:  
[marketing@verope.com](mailto:marketing@verope.com) | [www.verope.com](http://www.verope.com)

## TECHNICAL BROCHURE □

Provides background information on rope construction, different rope types and useful tips for the correct handling of special wire ropes.



## HEAVY INDUSTRY □

This segment brochure helps you select the perfect verope® special wire rope for your application.



## □ HANDLING BROCHURE

Offers important information and explanations, that help our customers to handle special wire ropes correctly and safely.



## □ CONSTRUCTION INDUSTRY

This segment brochure helps you select the perfect verope® special wire rope for your application.

## GENERAL CATALOG □

All verope® special wire ropes combined in a complete catalog and sorted by application.



## PORT INDUSTRY □

This segment brochure helps you select the perfect verope® special wire rope for your application.



## □ IMAGE BROCHURE GROUP

The verope® Group and its worldwide locations introduce themselves.



## □ DECK CRANES

This segment brochure helps you select the perfect verope® special wire rope for your application.

## IMAGE BROCHURE KV □

Worldwide technology leader:  
Kiswire verope® R&D Center for research and development.



## OFFSHORE INDUSTRY □

This segment brochure helps you select the perfect verope® special wire rope for your application.



**APPROPRIATE  
HANDLING OF VEROPE®  
SPECIAL WIRE ROPES**

Edition November 2024

All rights reserved.  
Copyright 2024 verope® AG.

Reprint or reproduction of any  
material in part or in whole only  
with express written consent of  
the publisher.

Printed on environmentally  
friendly FSC® paper.

**verope** ®  
rely on

**verope® AG**

St. Antons-Gasse 4a  
CH-6300 Zug / Switzerland  
Tel: +41 (0) 41 72 80 880  
Fax: +41 (0) 41 72 80 888

**[www.verope.com](http://www.verope.com)**  
**[info@verope.com](mailto:info@verope.com)**