



OCTOBER 2024

# **Original operating instructions** for verope<sup>®</sup> special wire ropes

**DISCLAIMER**

This document been translated using machine translation. We do not accept any liability for translation errors. The English version on our website is valid, and you can find the latest version of all our documents here:



<https://verope.com/downloads>

**TABLE OF CONTENTS**

0	WARNINGS .....	5
0.1	Putting on PPE (personal protective equipment) .....	5
0.2	Pictograms - danger and mandatory signs.....	5
1	INTRODUCTION .....	7
1.0	Information on the manufacturer .....	7
1.1	Intended use .....	7
1.2	Reasonably foreseeable misuse .....	8
1.3	List of special wire ropes for which these operating instructions are valid.....	8
1.4	Target groups.....	9
1.5	Documents.....	9
1.6	Life cycle .....	11
2	HEALTH, SAFETY AND ENVIRONMENT .....	11
2.1	Precautionary measures / safety instructions.....	11
2.2	Operational safety measures.....	12
2.3	Medical emergency measures .....	13
2.4	Safety instructions - risk of fire or explosion.....	13
2.5	Disposal of the product or packaging material .....	13
2.6	Duty of care of the operator.....	13
2.7	Duty of care of the user .....	13
2.8	Deadlines for periodic inspections.....	14
2.9	Information from ISO 4309 .....	14
3	ROPE SELECTION.....	14
3.1	Definitions .....	13
3.2	Rope end connections .....	25
3.3	Guide to wire rope selection.....	27
3.4	Technical data.....	32
3.5	Reference to catalog or data sheets .....	33
3.6	General information .....	33
4	PACKAGING, TRANSPORT, HANDLING AND STORAGE.....	34
4.1	Product labeling.....	31
4.2	Storage, handling & installation.....	35
5	INSTALLATION .....	41
5.1	Installation instructions.....	41
5.2	Installation.....	42
5.3	Installation examples .....	45
5.4	Troubleshooting .....	50

6 INSPECTION AND PERIODIC MAINTENANCE ..... 52

6.1 Types of inspection..... 52

6.2 Tools required for the inspection..... 53

6.3 Discard criteria..... 54

6.4 Other wire rope damage..... 57

7 MAINTENANCE ..... 58

7.1 Maintenance of the wire rope..... 58

7.2 Relubrication of special wire ropes ..... 58

7.3 Removing the ends of broken wires..... 60

7.4 Replacing the wire rope / dismantling Decommissioning..... 61

8 TRACKING ..... 62

**0 WARNINGS**

**0.1 Putting on PPE (personal protective equipment)**

**Putting on PPE**

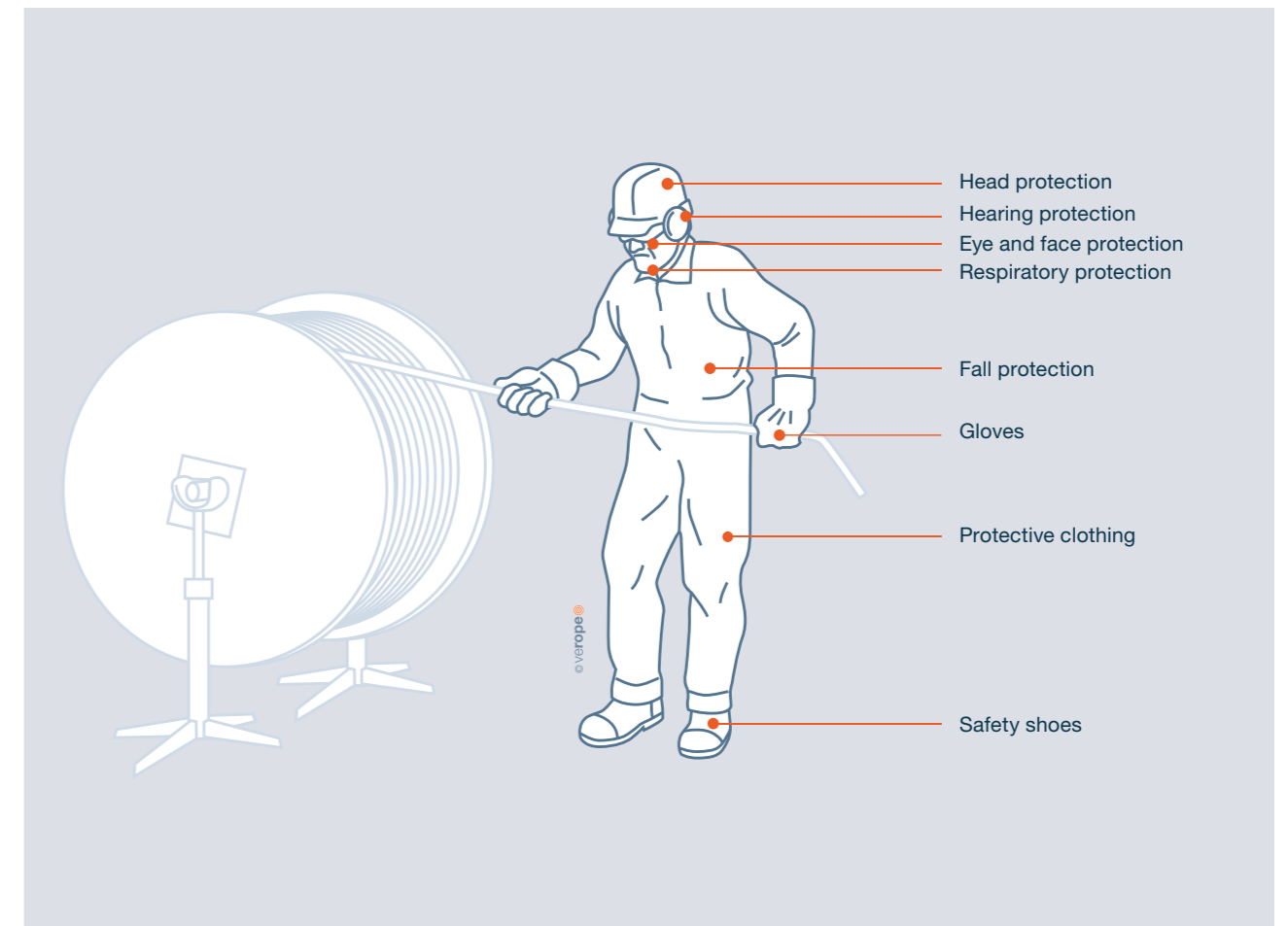

**0.2 Pictograms - Danger and mandatory signs**

**General warnings**



Danger / Caution / General warning



Danger / Caution / Warning of hand injury



Danger / Caution / Burns

**Commandment sign**

General mandatory sign



Use hearing protection



Use eye protection



Use foot protection



Use hand protection



Use protective clothing



Use face protection



Use head protection



Use safety vest



Use respiratory protection



Use safety harness

**1 INTRODUCTION****1.0 Details of the manufacturer**

Name	verope® AG
Adresse	Sankt-Antons-Gasse 4A, 6300 Zug, Switzerland
E-Mail	info@verope.com
Phone	+41 41 72 808 80

**1.1 Intended use**

Intended use: wire ropes as machines or parts of machines may only be used for their intended purpose. All verope® special wire ropes may only be used for lifting purposes as part of hoisting equipment or lifting accessories. Any other use is considered improper and excludes the manufacturer's liability. Proper use also means that the wire ropes may only be used in compliance with the relevant standards and the specifications of the respective crane manufacturer. Particular attention must be paid to the maximum permissible load and the permissible operating conditions (maximum bending radius, maximum deflection angle, maximum temperature, etc.). Independent reduction of the safety factors specified by the machine by the user is not permitted and, in the worst case, can endanger life and limb and result in additional high damage costs. verope® special wire ropes and their end connections may only be installed in an approved system whose dimensions (e.g. openings, bolts, etc.) are adapted to the respective end connection and wire rope end. In case of doubt, verope® AG must be consulted. The user must ensure adequate inspection and maintenance of the wire ropes. If there is any doubt about the suitability of verope® special wire ropes for their intended use, verope® AG must be consulted. If laws or regulations apply in the country of use that go beyond the generally known standards and regulations, these must be observed.

Pierre Verreet, CEO

verope® AG | St. Antons Gasse 4a | CH-6300 Zug ZG – Switzerland

Tel: + 41 (0) 41 72 80 880 | www.verope.com

verope® special wire ropes for general lifting purposes as part of lifting gear or load handling equipment.

## 1.2 Reasonably foreseeable misuse

Reasonably foreseeable misuse	Possible damage / residual risk
Misuse of the verope® special wire rope or the machine	Can lead to damage or wire rope breakage
Failure to observe the maximum permissible load and installation conditions	Can lead to premature discarding or wire rope breakage
Small bending radius, max. deflection angle, etc.	Can lead to premature wire rope damage, short wire rope service life and possibly wire rope breakage
Independent reduction of the safety factors specified by the machine	Can lead to overloading and wire rope breakage or system failure
Insufficient inspection and maintenance	Can lead to premature wire rope discard or wire rope breakage
Improper storage	Can lead to premature discarding or wire rope breakage
Use of non-galvanized special wire ropes in the offshore sector	Can lead to premature discarding or wire rope breakage
Use of Lang lay wire ropes in cargo handling operations	May lead to wire rope breakage if discard maturity is not recognized
Shock load	May lead to wire rope breakage if discard maturity is not recognized
Damage due to heat or electrical influences	May lead to premature discard maturity or wire rope breakage
Working with plastic sheaves or non-metallic sheaves without adjusting the discard criteria	May lead to wire rope breakage if discard maturity is not recognized

## 1.3 List of special verope® wire ropes for which these operating instructions are valid

### Rotation-resistant wire rope constructions

Rotation-free wire ropes have at least 14 outer strands and a steel wire rope core laid in opposite directions

verotop P  
verotop XP  
verotop  
verotop S  
verotop S+  
verotop E

### Semi-Rotation-resistant wire rope constructions

A rotation-resistant wire rope construction consists of four wire rope strands, which are only manufactured in a cross lay design.

vero 4

## Non-rotation-resistant wire rope constructions

Non-rotation-resistant wire ropes have a maximum of 12 outer strands and a steel wire rope core with the same lay direction as the wire rope.

verostar 8

veropro 8

veropower 8

verotech 8

verotech 10

verotower 8

veropro 8 RS

veropro 10

verotech 9

verosteel 8

## 1.4 Target Groups

Target Group	Work areas
End users/consumers	Crane operators, maintenance staff, machine operators, production workers, etc
Fitters	Crane operators, maintenance staff, etc.
Manufacturer	Crane drivers, installers, customers, production employees, etc.

## 1.5 Documents

- CE Declaration of Conformity
- Dokumentation Beschreibung
- Cable certificates - cable-specific technical data & test data
- Cable data sheets - general cable technical data
- Contract / General conditions - Contains contractually agreed data

- verope® Technical brochure
- verope® Handling brochure
- verope® General catalog
- verope® Terminations brochure

## EG-Konformitätserklärung

im Sinne der Maschinenrichtlinie 2006/42/EG Anhang II 1A

verope AG  
St. Antons Gasse 4a  
6300 Zug

Hiermit erklären wir, dass die nachfolgend bezeichnete Maschine

Produkt	verotop	Doku Nr.	AB11020531
Typ	ø8 / RHLL / ungalv. / 1960Nmm <sup>2</sup>	Kunde	10000079
Menge	60m	Bestellung	CPO 2024 T16110
Serien Nr.:	20501210	Bestelldatum	26.01.2024
Charge Nr.:	10064897		

Produkt:	verotop
Typ:	ø8 / RHLL / ungalv. / 1960Nmm <sup>2</sup>
Menge	60m
Serien Nr.	20501210
Charge Nr.	10064897

Produkt	verotop
Typ	ø8 / RHLL / ungalv. / 1960Nmm <sup>2</sup>
Serien Nr.	20501210
Charge Nr.	10064897

aufgrund ihrer Konzipierung und Bauart, sowie der von uns in Verkehr gebrachten Ausführung, den grundlegenden Sicherheits- und Gesundheitsanforderungen der Maschinenrichtlinie 2006/42/EG Anhang II 1A, sowie den unten aufgeführten harmonisierten und nationalen Normen sowie technischen Spezifikationen entspricht. Bei einer nicht mit uns abgestimmten Änderung der Maschine, verliert diese Erklärung ihre Gültigkeit.

EN 12385 1-7	Drahtseile aus Stahldraht
EN 13411 1-8	Endverbindungen für Drahtseile
ISO 21669	Drahtseile aus Stahldraht
VDI 2358	Drahtseile für Fördermittel
ISO 4309	Ablegereife von Hubseilen

Bevollmächtigter für die Zusammenstellung der technischen Unterlagen: Daniele Misticoni  
Quality Management

Zug, 12.09.2024

Pierre Verreet

  
CEO

## 1.6 Life cycle of verope® special wire ropes

Transportation  
Installation  
Operation  
Maintenance  
Dismantling  
Disposal

## 2 HEALTH, SAFETY AND ENVIRONMENT

### 2.1 Precautionary measures / safety instructions



verope® special wire ropes are designed and manufactured using the latest technology and in accordance with current safety regulations. The verope® product can be used safely if the instructions given in this manual are strictly adhered to. verope® accepts no responsibility for personal injury or damage to property resulting from the use of the products in disregard of the instructions given in this manual.

verope® special wire ropes may only be used, operated and maintained by authorized and specially trained persons. Read and follow the instructions in this operating manual in order to operate the system safely and to use the verope® special wire rope safely. Do not carry out any modifications or repairs to the device yourself. Always observe the current safety regulations.

#### Before using verope® special wire ropes, please observe the following points:

- Familiarize yourself with the work to be carried out by reading the user manual or operating instructions.
- Familiarize yourself with the safety precautions (emergency stop, escape routes, etc.) on site..
- Find out about the protective and safety features of the equipment and the application.



#### Before starting work, check the following points:

- The operating switches are in the OFF position, and adequate measures (fuses, panels, shut-off devices, etc.) have been taken to prevent accidental start-up of the system during work.
- Ensure safety during work by knowing the correct machine movement (direction of drum rotation, etc.).
- Switch off the system before starting work.
- Observe the instructions given in the relevant warnings during work.
- Make sure that every colleague, helper or other personnel is informed about potential dangers that may occur during or as a result of the work.
- Always work with the utmost concentration and anticipation.





- If protective devices have to be partially or completely removed to carry out special technical repair work, they must be removed at all times.
- Check that no tools or parts are left in the system.
- Make sure that the installation and the wire rope used operate safely.

## 2.2 Operational safety measures

When working with verope® special wire ropes, e.g. cutting, welding, grinding or cleaning, dust and vapors may be produced which can be hazardous to health.

Observe the locally applicable safety guidelines and wear appropriate personal protective equipment (PPE) at all times.



Use hearing protection



Use eye protection



Use face protection



Use foot protection



Use hand protection



Use protective clothing



Use head protection



Use safety vest

## 2.3 Medical emergency measure

### In case of inhalation of hazardous substances:

Remove affected person to fresh air and get emergency medical help immediately.

### In case of skin contact:

Wash affected areas directly with soap and water.

### In case of contact with eyes:

Flush eyes thoroughly with running water. Get medical attention immediately.

### If swallowed:

Give first aid and get emergency medical help immediately.

## 2.4 Safety instructions - risk of fire or explosion



In principle, the steel components of the wire rope pose only a low risk of fire or explosion. The safety data sheets for any plastics and lubricating greases present in the wire ropes must be observed accordingly and are available from verope® AG.

## 2.5 Disposal of the product or packaging material

Ensure that the wire ropes are handled in an environmentally friendly manner on site and when disposing of the packaging material and used wire ropes. To prevent environmental damage and injury: Do not leave any packaging material, wire ropes, tools or aids in the environment.

## 2.6 Duty of care of the operator

To ensure safe operation, the user of the machine must fulfill the following obligations:

- Regular maintenance
- Carry out safety instructions
- Carry out training
- etc.

## 2.7 Duty of care of the user

To ensure safe operation, the user of the machine must fulfill the following obligations:

- Read and follow the operating instructions
- Keep the workplace clean
- Wear the necessary protective equipment
- etc.

**2.8 Deadlines for recurring inspections**

Test part	Interval	Test type	To be tested by
verope® special wire rope	daily	Visual inspection	User/machine operator
verope® special wire rope	daily	Inspection	Qualified person
installation	regularly*	Inspection	Competent person

Determination of the inspection intervals in accordance with ISO 4309 or the competent expert.

**2.9 Information from ISO 4309**

**Regular inspection of the wire rope**

Thorough visual inspection including measurement of the wire rope and, where practicable, assessment of the internal condition of the wire rope.

Note 1 to entry: Where practicable, this inspection may include a magnetic wire rope inspection carried out by a competent person for wire rope inspection who is familiar with the use of MRI equipment and the evaluation of reference values.

**Qualified person for wire rope inspection**

Person with expertise and experience in the field of wire ropes on cranes and winches who is qualified to assess the condition of the wire rope, to assess whether the wire rope may remain in operation and to determine the maximum interval between inspections.

**3 ROPE SELECTION**

**3.1 Definitions**

**Rope technology basics - All about the wire**

**Raw material**

Rope wires are usually made from killed, unalloyed carbon steel with a prescribed degree of purity. The carbon content is between 0.4 % and 1 %, the manganese content between 0.3 % and 1 %, the silicon content between 0.1 % and 0.3 % and the phosphorus and sulphur contents each below 0.45 %.

**Manufacture**

Wire rod with a diameter of around 6 mm to 9 mm is first produced by hot forming. This is then brought to the desired strength and diameter in a cold forming process by drawing or rolling.

**Wire surfaces**

Galvanized wires are given a zinc coating when they pass through a bath of liquid zinc. If the wire is not further drawn after this treatment, it is called „final galvanized“. If the wire cross-section is further reduced after galvanizing, the wire is called „not finally galvanized or galvanized drawn“. Bare wire rope wires without coating are marked with the letter U, wire rope wires with zinc coatings of class B or A are marked with the letters B or A.

**Wire tensile strength**

The tensile strength of a wire is defined as the bearable tensile force in the longitudinal direction of the wire, divided by the wire cross-section. The nominal wire tensile strength is a theoretical value that the tensile strength of the wire must not fall below and may only exceed within defined limits. wire rope wires with nominal strengths of 1770 N/mm<sup>2</sup>, 1960 N/mm<sup>2</sup>, 2060 N/mm<sup>2</sup>, 2160 N/mm<sup>2</sup>, 2260 N/mm<sup>2</sup> and 2360 N/mm<sup>2</sup> are usually used in modern wire ropes.

**Wire forms**

A distinction is made between shaped and profiled wires. A shaped wire is a wire with a round cross-section, a profiled wire is any wire with a non-circular cross-section. There are oval wires, flat wires, Z and S profile wires, waist wires, wedge wires and triangular wires. Profile wires are produced by drawing or rolling.

**Wire hardness**

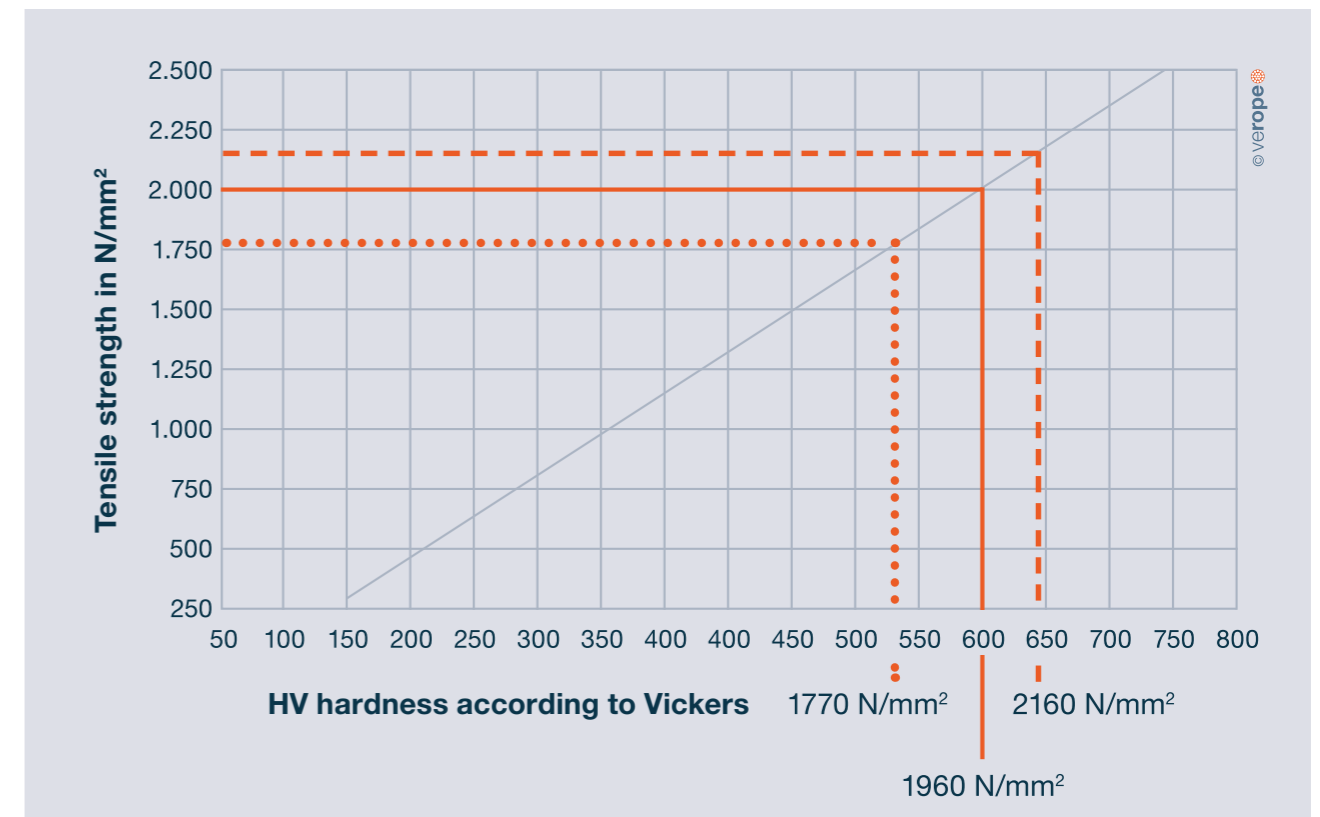

**Wire drawing process**

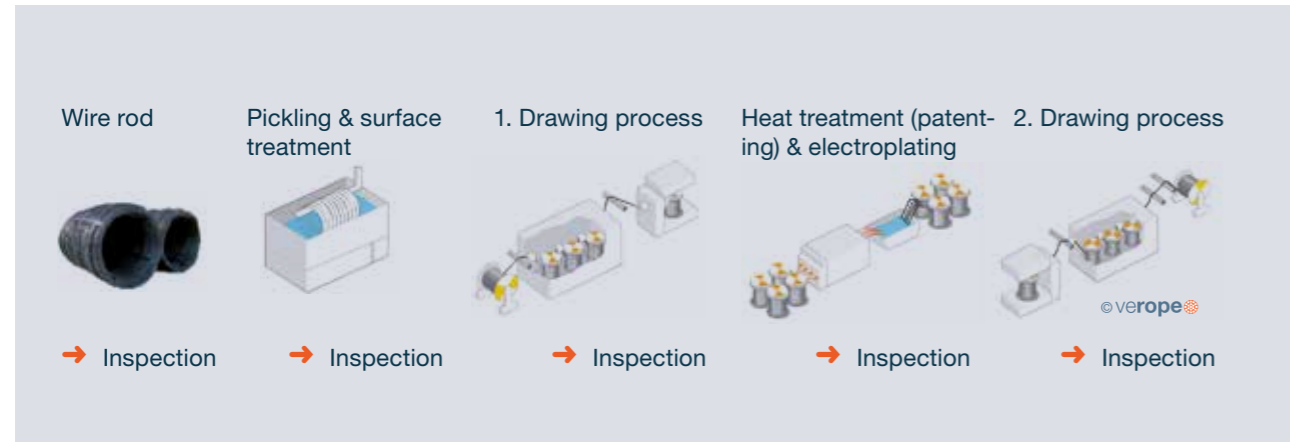

Unique verope® special wire ropes:

- high quality raw material
- modern design
- competent production & innovative wire rope testing
- unique design
- experience of specialists
- careful development based on computer-aided wire rope dimensioning
- produced by the world's largest wire product manufacturer using state-of-the-art machinery
- due to the manufacturer's own wire drawing process, the raw material is already of unique quality

**Rope technology basics - All about the strand**

A strand consists of one or more layers of wires wound helically around a core (Fig. 1).

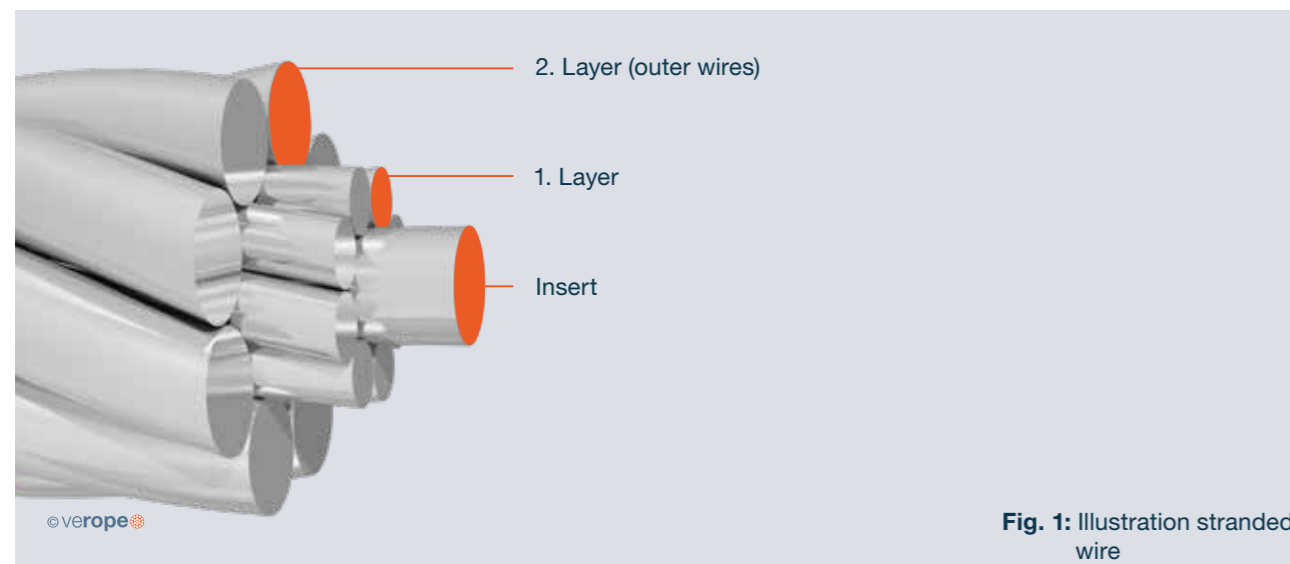

**Fig. 1:** Illustration stranded wire

**Strand lay length**

The lay length of a strand is the pitch of the helically laid wires, i.e. the length of the strand at which the wire runs completely around once. By changing the lay length, the contact ratios of neighboring wires, the elastic properties and the breaking forces of the strand can be changed.

**Lay direction of the strand**

A distinction is made between left-hand and right-hand lay strands. The lay direction of a strand is left-handed if its wires (moving away from the observer) are twisted counterclockwise (Fig. 2). The lay direction of a strand is clockwise when its wires (moving away from the observer) are twisted clockwise (Fig. 3). The lay direction of the strands is often indicated with the lower case letter s for the left-hand strand and the lower case letter z for the right-hand strand.

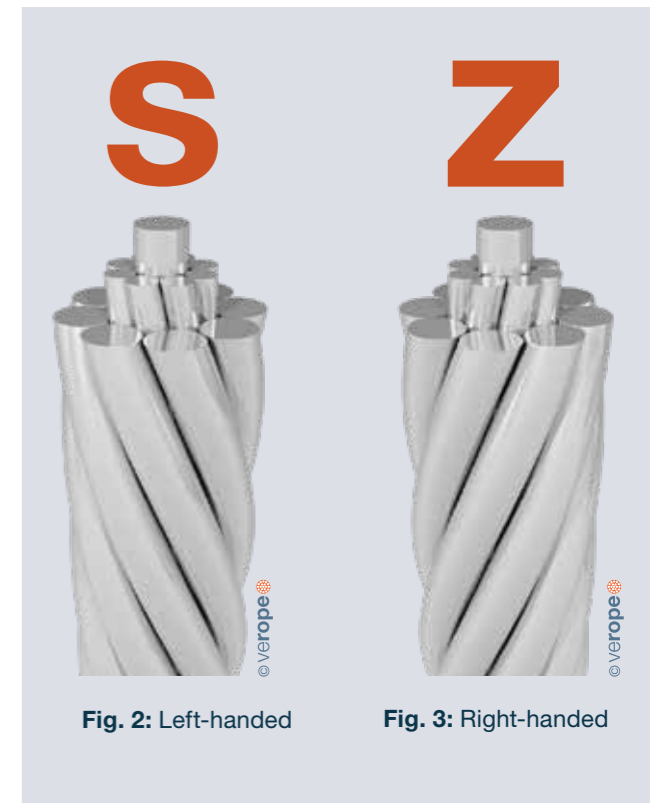

**Strand diameter**

The strand diameter is the diameter of all the outer wires enclosing the enveloping circle. The strand diameter is usually measured with micrometer screws and specified to an accuracy of 1/100 mm. (Fig. 4)

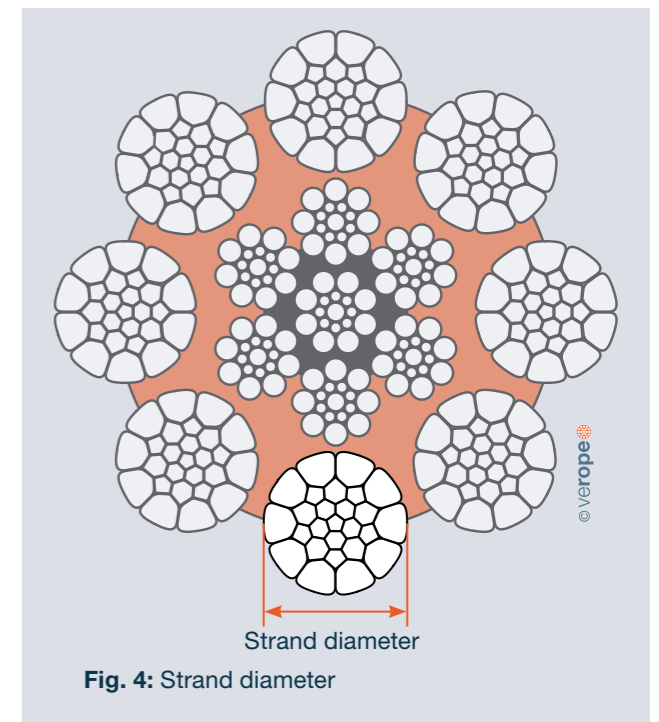

**Fig. 4:** Strand diameter

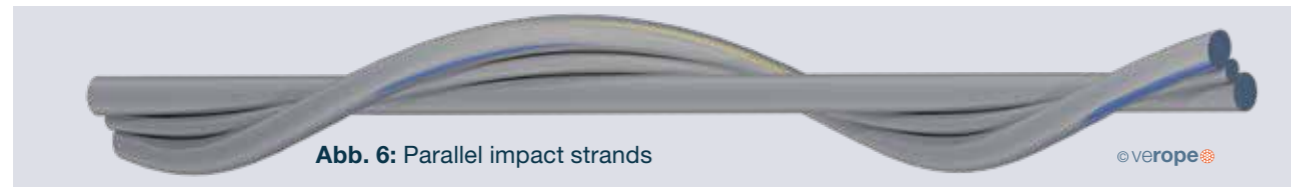
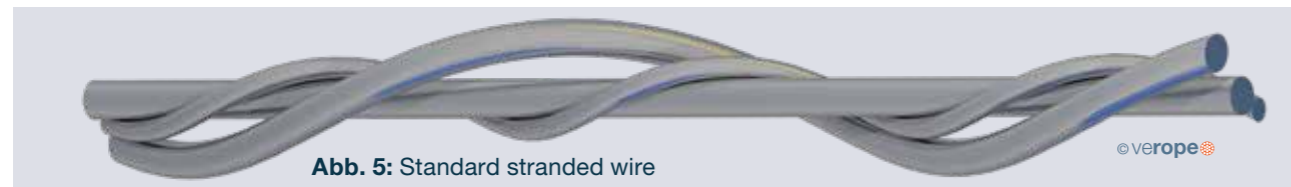

**Strand construction**

The construction of a strand is understood to be the formation law according to which the wires are arranged relative to each other. For example, all strands of the Seale type have the structure 1 - n - n (with n = 3, 4, 5, 6, 7, 8, 9 ...). In accordance with EN 12385-3, wire layers that are stranded parallel to each other in the same operation are connected in the designation by a minus sign. - . connected. The designation of a strand of type Seale 17 is therefore 1 - 8 - 8, the designation of a strand of type Seale 19 is 1 - 9 - 9.

The two- and three-layer standard strands have cross-overs between the wires of the different wire layers (Fig. 5). Here, the wire layers are stranded in separate operations in the same direction (short line N) with the same stranding angle but different lay lengths.

The so-called parallel lay strands (Seale, Filler, Warrington, Warrington-Seale) avoid crossovers and instead produce line contact of the wires (Fig. 6) by stranding all wire layers with different stranding angles but the same lay length.

The most important strand types are the single, double and triple layer standard strands (Fig. 5 and 7), as well as the parallel lay strands of the Seale, Filler, Warrington and Warrington-Seale types (Fig. 6 and 7).

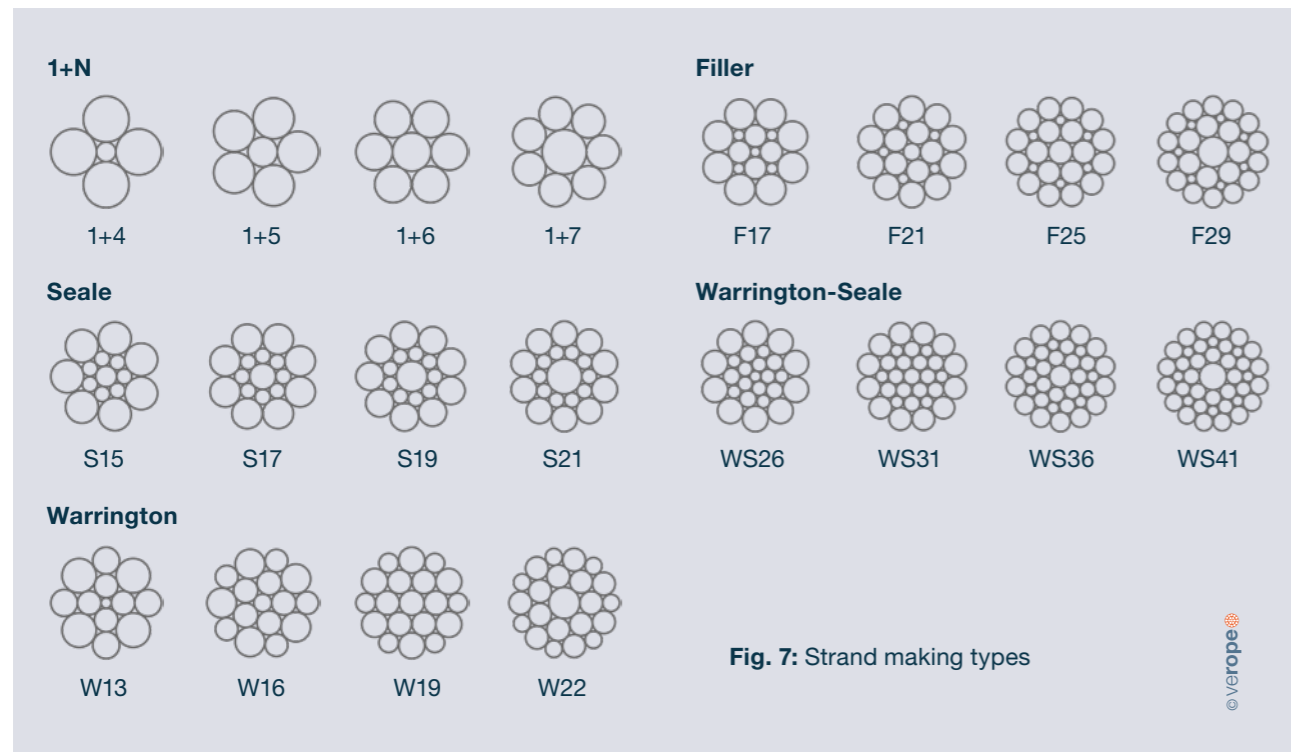

**Compacted round strands**

Compacted round strands are first produced conventionally from torsion-free stranded round wires. They are then compressed to a smaller diameter either in the same or in a separate work step, for example with the help of

drawing dies or rollers, whereby the originally round wires are severely deformed on the compression tool and on the adjacent wires (Fig. 8).

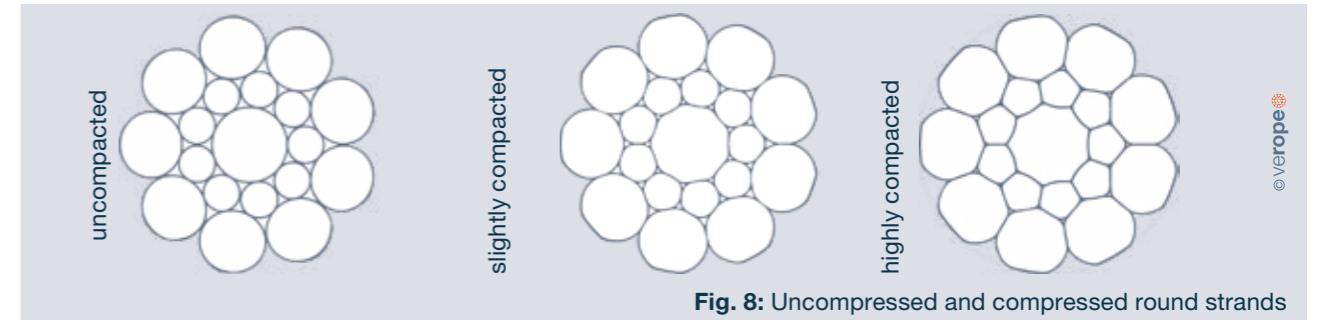

**Fill factor of the strand**

The fill factor of a strand is the quotient of the metallic cross-section of the strand (simplified by definition as the sum of the individual wire cross-sections) in relation to the area of the smallest circle circumscribing the strand. The fill factor indicates what proportion of the space occupied by the strand in the wire rope is filled with steel. The fill factors of the most commonly used strands are approximately between 0.70 and 0.82. This

means that the proportion of steel in the strand volume is approximately 70% to 82%. The fill factors of the strands can be increased considerably through compaction. The fill factor of a strand generally increases as the number of wires increases. For example, a Seale 15 (1 - 7 - 7) strand has a fill factor of around 0.77 and a Seale 19 (1 - 9 - 9) strand has a fill factor of around 0.79.

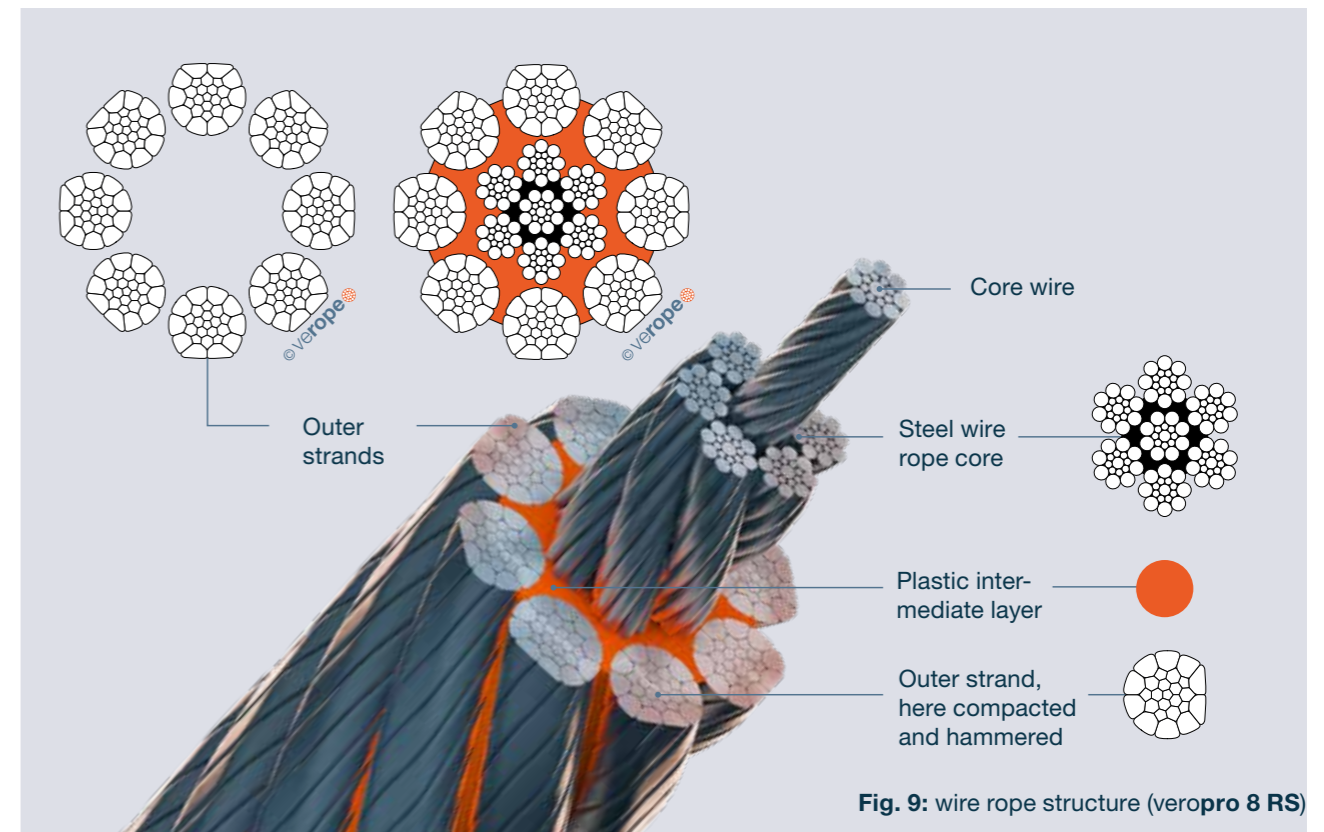

**Rope technology basics - All about the wire rope**

**Wire rope diameter**

A distinction is made between a nominal wire rope diameter and an effectively measured wire rope diameter (actual wire rope diameter).

The nominal wire rope diameter, also known as the nominal wire rope diameter, is an agreed theoretical value for the diameter of the smallest circle circumscribing the outer strands.

The wire rope diameter, also known as the actual wire rope diameter or real wire rope diameter, is the diameter of the smallest circle circumscribing the outer strands actually measured on the wire rope.

The tolerance range for the actual wire rope diameter is specified in the tables of the respective national or

international standards. According to EN 12385-4, it is 0 % to +5 % (rope diameter for  $\geq 8$  mm). This means that when the wire rope is delivered, the actual wire rope diameter must not be smaller than the nominal diameter, but must also not exceed it by more than 5%. In the case of thin wire ropes, e.g. 3 mm to 7 mm, the tolerance field is often larger at the top. In the oil industry, which is strongly oriented towards American specifications, a tolerance range of -1% to +4% often applies. Of course, the actual wire rope diameter changes depending on the wire rope load. Therefore, in borderline cases, the actual wire rope diameter should be measured on a wire rope loaded with 5 % of the calculated breaking force. verope® produces wire ropes with standard tolerances of +2 % to +4 %; special wire rope diameter tolerances are manufactured on request

**Measuring instruments and their correct use**

To determine the exact diameter of the wire rope, you need a special measuring instrument. In principle, measurements should be taken on the vertices (outer circle of the wire rope sheath). Measuring in the hollows of the strands

considerably distorts the result. For wire ropes with an uneven number of outer strands, ensure that the measuring surfaces extend over several strands. (fig. 10).

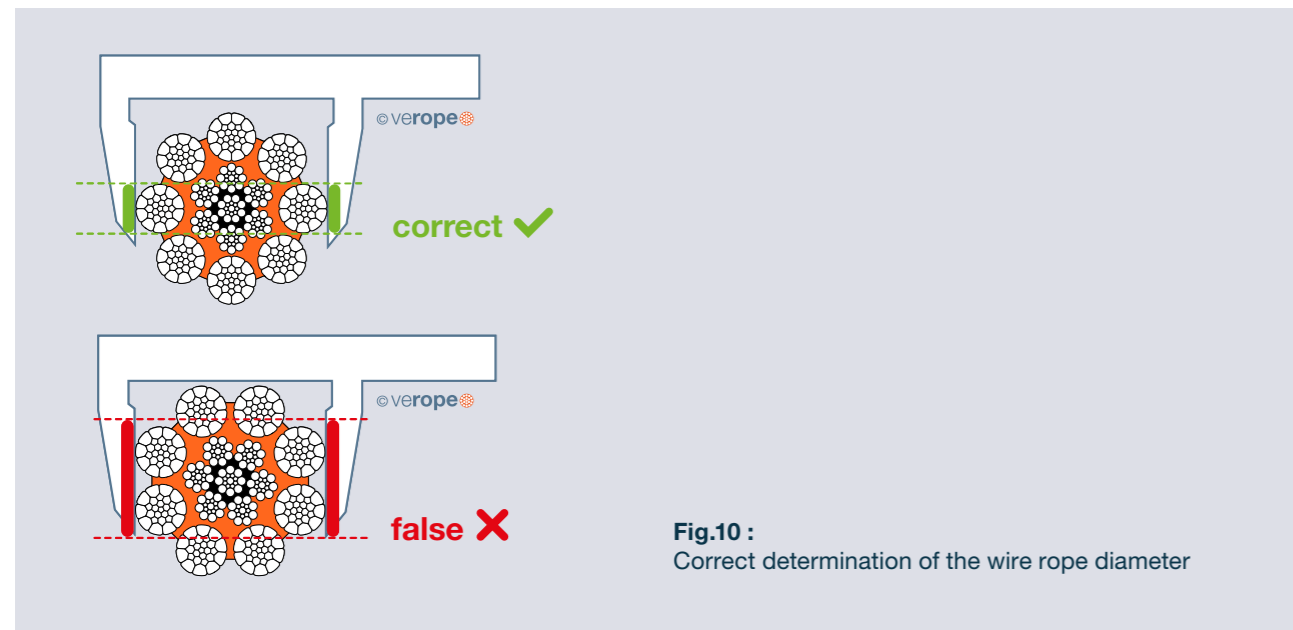

**Fig.10 :** Correct determination of the wire rope diameter

**Types of measuring equipment**

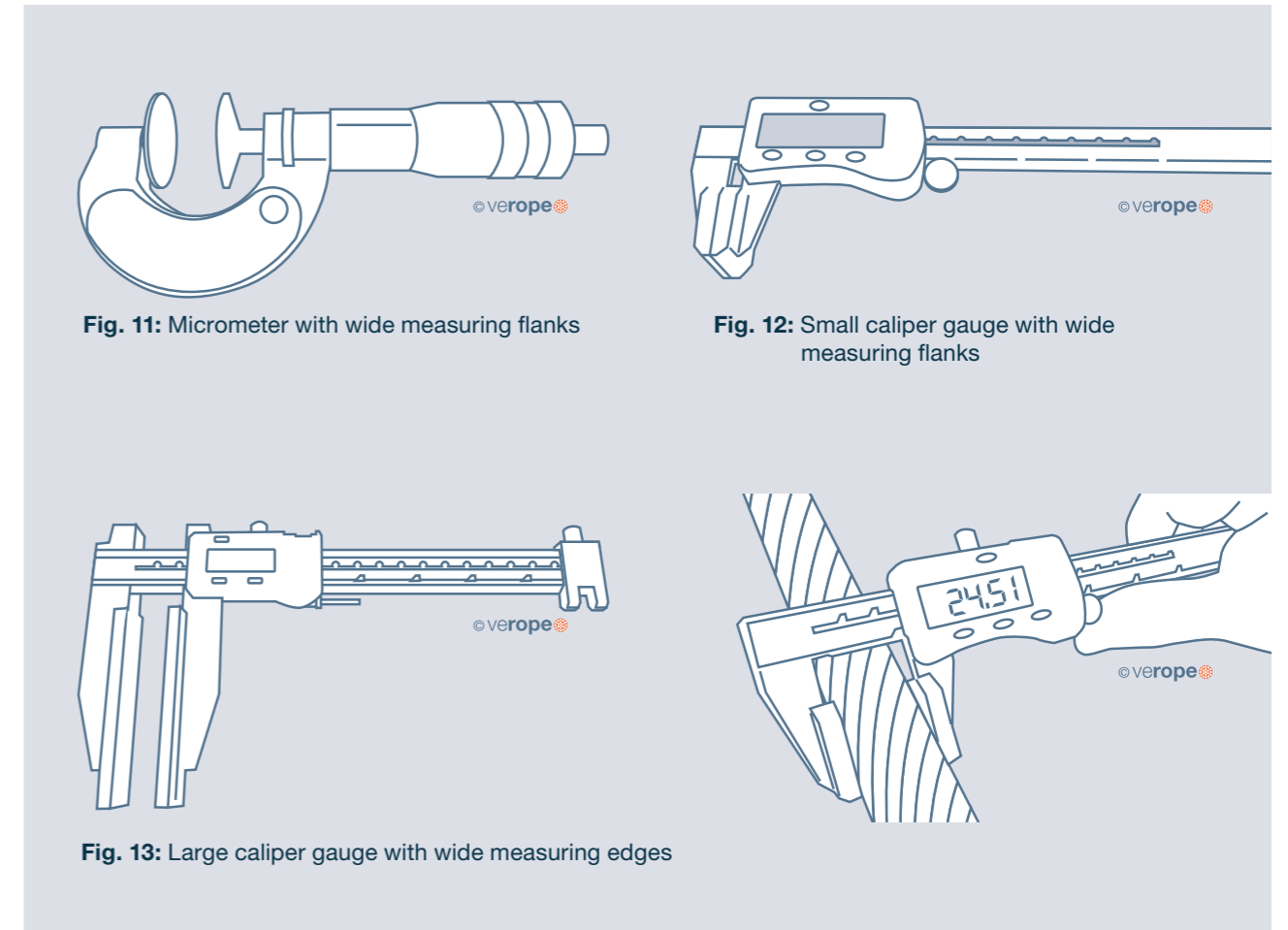

**Fig. 11:** Micrometer with wide measuring flanks

**Fig. 12:** Small caliper gauge with wide measuring flanks

**Fig. 13:** Large caliper gauge with wide measuring edges

**Lay direction of the wire rope**

A distinction is made between right-hand and left-hand lay wire ropes. The lay direction of a wire rope is left-handed if its strands (moving away from the observer) are rotated counterclockwise (Fig. 14). The lay direction of a wire rope is clockwise when its strands (moving away from the viewer) are rotated clockwise (Fig. 15). The lay direction of wire ropes is often indicated by the capital letter S for the left-hand wire rope and the capital letter Z for the right-hand wire rope. Right-hand wire ropes are also often designated as RH (for right hand) and left-hand wire ropes as LH (for left hand).



**Fig. 14:** Left-handed

**Fig. 15:** Right-handed

### Wire rope construction

The construction of a wire rope refers to the formation law according to which the elements of the wire rope, i.e. its wires and strands, are arranged relative to each other. The designation for a fiber core is FC (Fibre Core), for an inde-

pendent steel wire rope core is IWRC (Independent Wire rope Core). For example, all round strand wire ropes of the 6 x 19 Warrington type with a fiber core have the structure 6 x [1-6-(6-6)] - FC.

### Fill factor of the wire rope

The fill factor of a wire rope is the quotient of the metallic cross-section of the wire rope (simplified by definition as the sum of the individual wire cross-sections) in relation to the cross-section of the smallest enveloping circle of the wire rope. The fill factor indicates what proportion of the space occupied by the wires and strands in the wire rope is filled with steel (Fig. 16).

The fill factors of the most common wire ropes are approximately between 0.46 and 0.75. This means that the proportion of steel in the wire rope volume is approximately 46% to 75%. Wire ropes with a steel core have higher fill factors than wire ropes with a fiber core. For example, a 6 x 25 Filler - FC wire rope has a fill factor of 0.50, while a 6 x 25 Filler - IWRC wire rope has a fill factor of 0.58. The fill factors of wire ropes with fiber cores (FC) generally decrease as the number of outer strands increases. A wire rope of the 6 x 25 Filler - FC type has a fill factor of 0.50, a wire rope of the 8 x 25 Filler - FC type has a fill factor of only 0.45. The fill factors of wire ropes with a steel wire rope core (IWRC) generally increase as the number of outer strands increases. A wire rope of the type 6 x 25 Filler - IWRC has a fill factor of 0.58, a wire rope of the type

8 x 25 Filler - IWRC a fill factor of 0.59.

Fig. 16: The fill factor of the wire rope is the ratio of the wire cross-sections (white areas) to the cross-sectional area of the smallest enveloping circle (white plus gray areas).

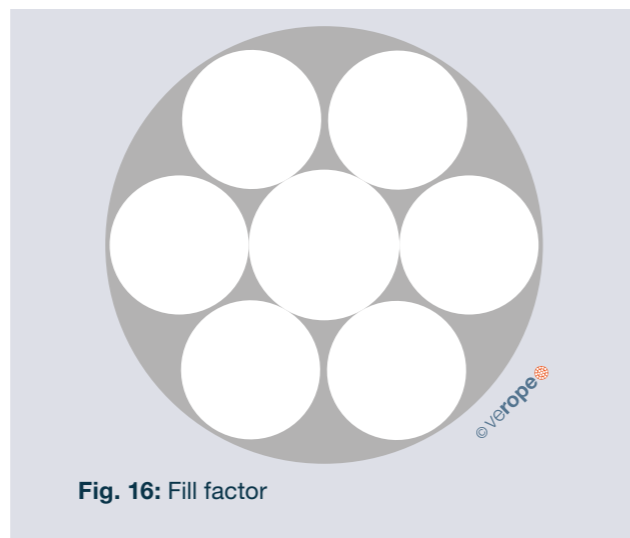

Fig. 16: Fill factor

Wire ropes made of compacted strands have higher fill factors than wire ropes made of non-compacted strands. The fill factor of wire ropes can be increased even further by hammering.

In regular lay wire ropes, the wires in the strands have the same lay direction as the strands in the wire rope. We distinguish between left-hand lay (left-hand lay strand, left-hand lay wire rope, sS) (Fig. 19) and right-hand lay (right-hand lay strand, right-hand lay wire rope, zZ) (Fig. 20).

### Type of lay of the wire rope

We distinguish between cross lay and regular lay. In cross lay wire ropes, the lay direction of the wires in the strands is opposite to the lay direction of the strands in the wire rope. We distinguish between left-hand cross lay (strand laid on the right, wire rope laid on the left, zS) (see Fig. 17) and right-hand cross lay (strand laid on the left, wire rope laid on the right, sZ) (see Fig. 18).

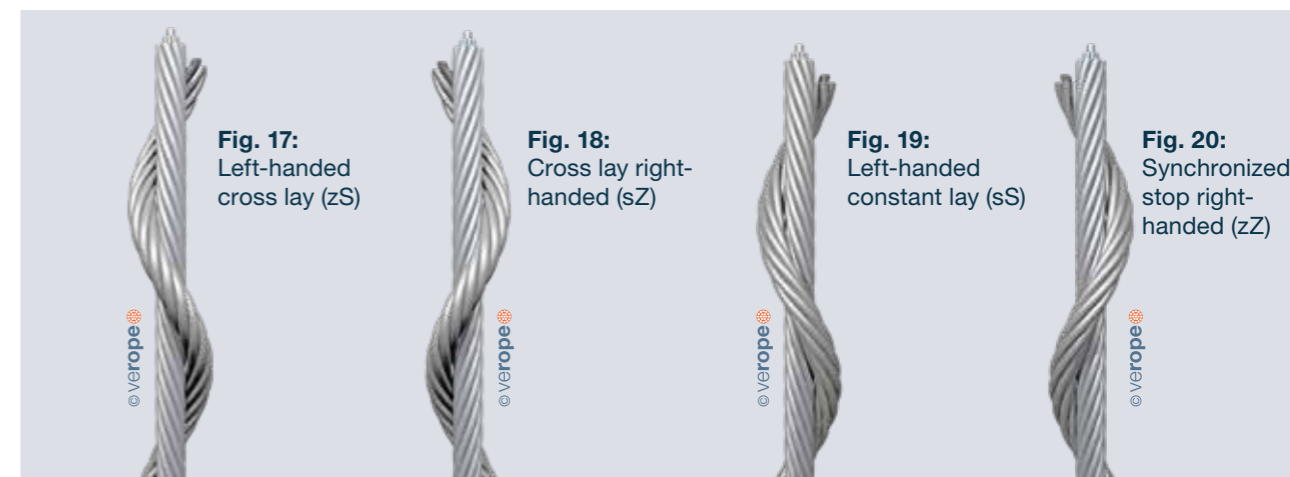

### The advantages of cross lay wire ropes are:

- Better structural stability
- Higher number of discard wire breaks
- Easier detection of wire breaks

### Low-tension wire ropes

During stranding and stranding, the originally straight wires are forced into a helix or double helix. As a result, the wires are under tension even in the unloaded wire rope. With the help of a so-called preforming head, the wires and strands can be plastically deformed during stranding or stranding to such an extent that they lie completely or almost completely unstressed (the wire roper says: dead) in the wire rope after elastic recovery. A non-stressed wire rope must be tied off very tightly to the left and right of the cutting point before it is cut, as otherwise the wire ends that become free will spring open.

### Types of wire rope core

(Abbreviations according to EN 12385-2) Wire ropes usually have a fiber core (FC) or a steel core. The steel core can be a strand (WSC), a wire rope stranded independently, i.e. in a separate operation (IWRC) or a wire rope stranded in parallel with the outer strands in the same operation (PWRC (Parallel Wire rope Core)). The steel core can also have a plastic coating (designation EPIWRC). Cores made of compacted strands bear the suffix (K). An independent steel wire rope core made of compacted strands therefore bears the designation IWRC (K), while a wire rope made of compacted strands stranded parallel to the outer strands in the same operation bears the designation PWRC (K).

### The advantages of Lang lay wire ropes are:

- Better fit to the wire rope groove
- Higher wear resistance
- Longer service life with high dead loads
- Significantly better behavior with multi-layer winding

### Rotation-resistant wire ropes

Under the effect of a tensile load, wire ropes with a free wire rope end rotate more or less strongly around their longitudinal axis.

Wire ropes with a steel wire rope core, which is laid in the opposite direction to the outer strands, as well as three- or four-strand cross lay wire ropes, exhibit significantly less rotation than wire ropes with a steel wire rope core laid in the same direction or wire ropes with a fiber core.

According to VDI guideline 2358, a wire rope is considered to have low rotation resistance if it rotates only slightly around its longitudinal axis under the effect of an unguided load and/or if it exerts only a small torque on the wire rope end connection when the wire rope ends are guided. ISO 21669 and EN 12385-3 define a wire rope as rotation-resistant if it rotates around itself at least once and at most four times (between 360° and 1440°) over a length of 1000 x wire rope diameter and an axial load of 20% of its minimum breaking load.

**Rotation-free wire ropes**

According to VDI guideline 2358, a wire rope is rotation-free if it hardly rotates about its longitudinal axis under the effect of an unguided load and/or if it hardly exerts any torque on the wire rope end connection when the wire rope ends are guided.

ISO 21669 and EN 12385-3 define a wire rope as rotation-free if it rotates around itself no more than once (between -360° and 360°) over a length of 1000 x wire rope diameter and an axial load of 20% of its minimum breaking load.

**Wire rope lubricant**

The wire rope lubricant has two main tasks: Firstly, it should protect the wire rope against corrosion and secondly, it should reduce the coefficient of friction between the wire rope elements and between the wire rope and sheave or drum. A reduction in the coefficient of friction reduces the required drive power and the wear on the wire rope, sheave and drum. We differentiate between wax-based lubricants and oil-based lubricants. While wax-based lubricants allow better handling, oil-based lubricants have the advantage that a torn lubricating film can close again automatically under the effect of gravity. The quality of the lubricant has a considerable influence on the service life of the wire rope (Fig. 21).

**Relubrication**

Wire ropes are always intensively lubricated during production. However, this lubrication must be renewed several times during the service life of the wire rope. Regular relubrication significantly increases the service life of the wire rope (Fig. 22). It must always be ensured that the relubricant is compatible with the basic lubrication. It is recommended to follow the maintenance instructions in ISO 4309.

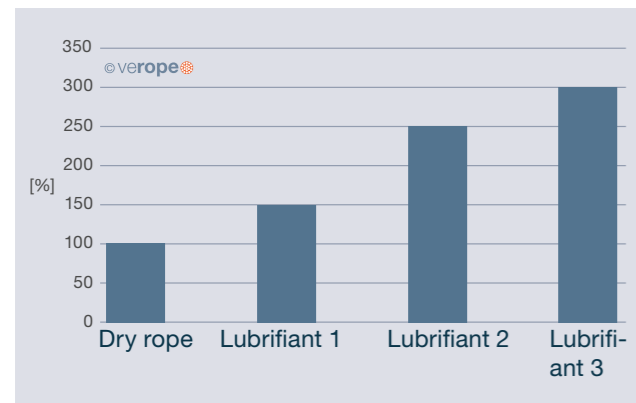

**Fig. 21:** Influence of the lubricant on the service life of the wire rope

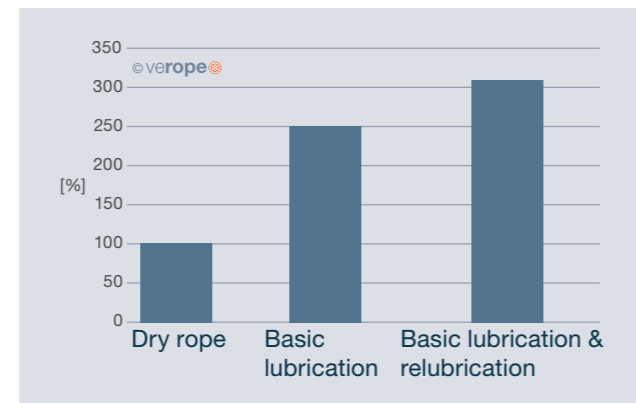

**Fig. 22:** Influence of relubrication on wire rope service life

**3.2 wire rope end connections**

**Dimensional reference points for exact wire rope length determination**

The wire rope length is very important for certain wire rope applications, e.g. holding and tensioning wire ropes. With the help of the following terminology, we would like to explain the important dimensional reference points for length determination and show some typical examples. This should help you to use the abbreviations explained in your order to avoid confusion when specifying lengths. In addition to the dimensional reference points, it is of course also important to specify the force under which the length is to apply. If no force is specified, it is assumed that the wire rope force  $F = 0$  kN.

Shortcut	Length reference point
AP	Attachment point
MB	Center colt
SP	Support point

- $MB - MB = 17000$  mm ( $F = 32$  kN)
- $MB - SP = 3715$  mm ( $F = 10$  kN)
- $MB - AP = 12500$  mm
- $AP - AP = 4320$  mm
- $AP - SP = 5725$  mm
- $SP - SP = 10415$  mm ( $F = 25$  kN)

**Fig. 23:** wire rope end connections

## Remaining breaking force of the wire rope end

### terminations Efficiency factor KT of wire rope end terminations

The minimum breaking force of a wire rope specified in the data sheet is a „...specified value in kN, which must not be less than the breaking force measured in a prescribed breaking force test“ (source: DIN EN 12385-2, 3.10.10). It is particularly important for the crane designer to know what influence a selected wire rope end connection has on the

the selected wire rope end connection has on the transmissible breaking force of the wire rope-rope end connection system. The minimum test force to be achieved when testing a wire rope end connection in the tensile test is determined in relation to the minimum breaking force of the wire rope, taking into account the efficiency factor KT.

KT = 0.9 means that the test force to be achieved must be at least 90% of the minimum wire rope breaking force.

Unless otherwise specified, the following basic rules apply:

KT=1.0 for grouted wire rope end terminations

KT=0.9 for swaged wire rope end terminations

KT=0.8 for wedge end clamps.

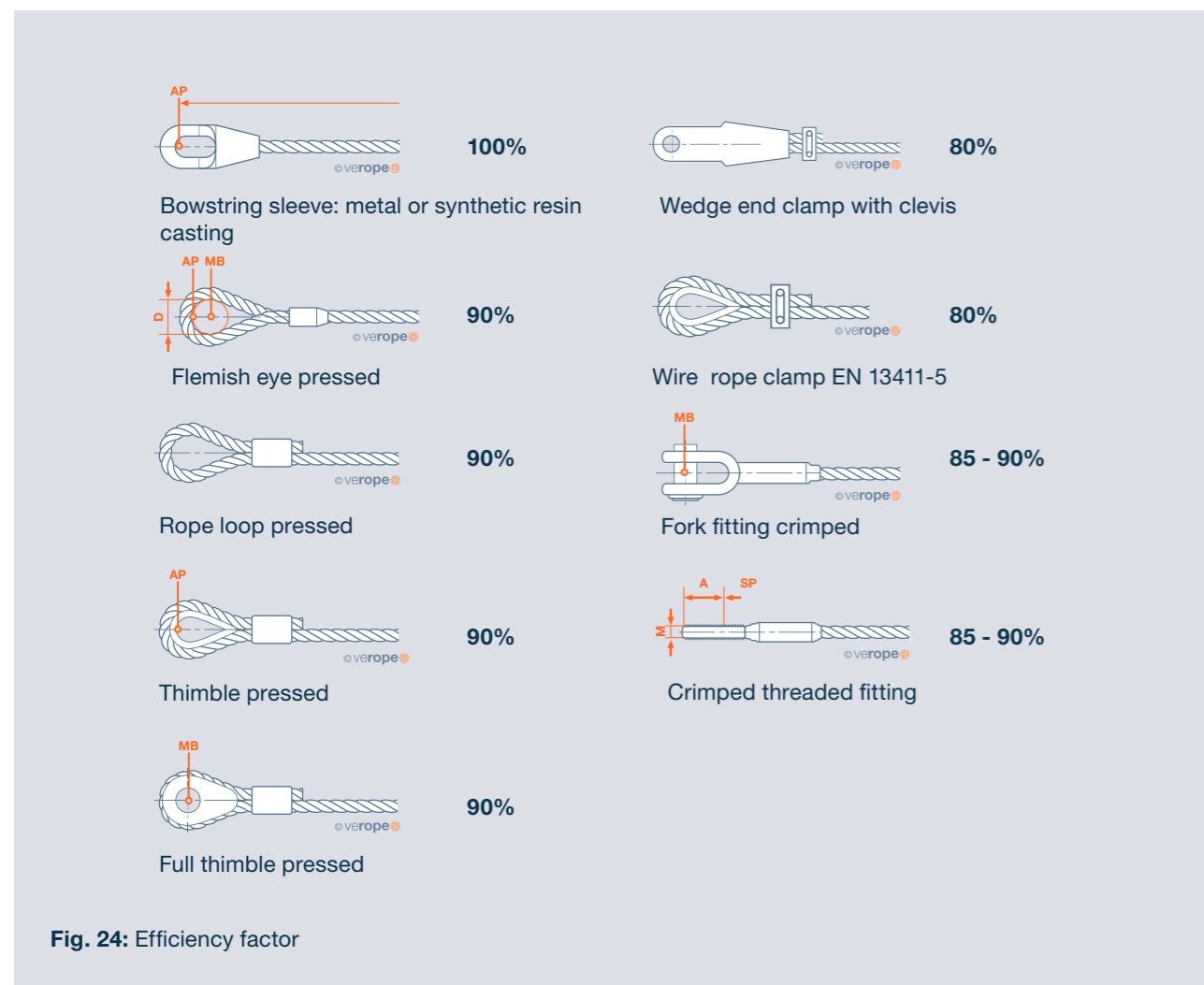

Fig. 24: Efficiency factor

## Requirements for wire ropes from the crane's point of view - General

When selecting a wire rope, it is always necessary to carefully check which operating and therefore wire rope stress conditions dominate from the crane's point of view. These stress conditions differ significantly and justify the production of special wire ropes, i.e. solutions tailored to the application that can fulfill these dominant requirements in the best possible way.

Of course, there are wire ropes that already cover the essential requirements of their design class very well. From

our product range, the wire ropes veropro 8 for non-rotation-resistant applications and verotop for rotation-resistant applications. Of course, there are also the real „specialists“, wire ropes with special strengths, which you can rely on for dominant requirements, e.g. wear resistance, lateral pressure stability or fatigue strength.

We will be happy to assist you in selecting the best possible wire rope for your application.

### 3.3 Guide to wire rope selection

#### The right wire rope selection for your wire rope application - details

When selecting a wire rope, two points of view must be reconciled: the wire rope selection from the point of view of the application and from the point of view of the wire rope. There is no such thing as a „universal wire rope“ that is equally suitable for all applications. This is why there is a wide range of different wire rope constructions to best meet the various requirements of the applications. With the following explanations, we would like to provide you with some practical information to help you select the right wire rope for your application. The verope® team will of course be happy to answer any questions you may have.

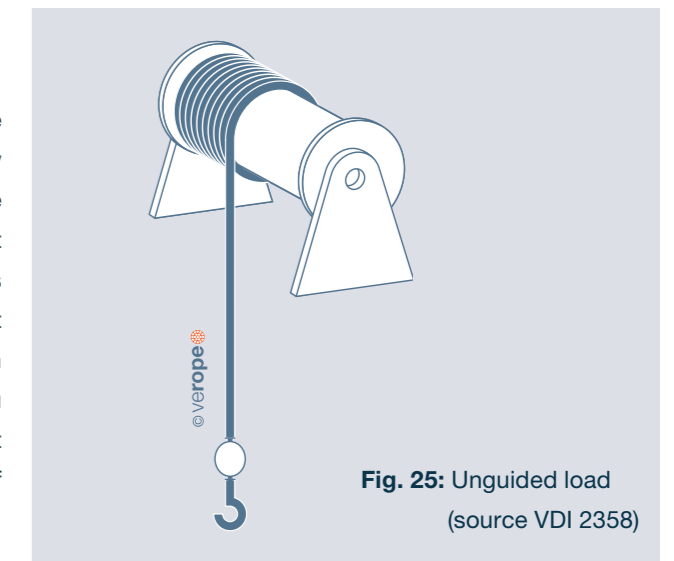

Fig. 25: Unguided load (source VDI 2358)

#### Rope selection from an application perspective

The main task of a crane is to lift and move loads, for which a hoist wire rope is required. In addition to this crucial „lifting function“, there are many other functions.

- Adjustment wire ropes to bring the boom into the correct position
- Trolley wire ropes to move the load on tower cranes/ container cranes
- Holding wire ropes to hold the boom or other crane parts
- Assembly wire ropes to erect or dismantle the crane
- ... and many more

#### Lifting function

There are two main categories into which crane wire ropes can be divided based on their application:

- Rotation-resistant ropes, often referred to as rotation-free ropes or strand spiral ropes in common parlance
- Non-rotation-resistant wire ropes

Only rotation-resistant wire ropes give the load the necessary stability so that the load does not rotate or only rotates very slightly. In addition, rotation-resistant wire ropes attached to the crane structure only generate very low torques at the attachment point. The low-rotation verope® special wire ropes therefore guarantee safe lifting of the load and thus safe crane operation.

The wire ropes designated as „rotation-resistant“ according to the standard differ significantly in their design and therefore in their characteristics with regard to freedom from rotation. A classification is used to show these differences in freedom from rotation. For example, EN 12385-4 designates the wire rope class „35x7“, which describes rotation-resistant wire ropes with 3 strand layers, and the wire rope class „18x7“, which describes rotation-resistant wire ropes with 2 strand layers. The freedom of rotation of both wire rope classes, but also the wire rope manufacturing costs and therefore the prices for the customer, are very different.

A further example to illustrate the different freedom of rotation is the classification according to ASTM A 1023, which divides rotation-resistant wire ropes into 3 categories. The most common categories for lifting functions are „Category 1“ and „Category 2“:

**Category 1:** rotation-resistant wire ropes with at least 15 outer strands offer the best properties in terms of freedom from rotation.

**Category 2:** rotation-resistant wire ropes with 10 or more outer strands.

With regard to the comparability of both standards, it can generally be said that wire ropes of wire rope class „35x7“ have a comparable freedom of rotation resulting from the wire rope construction as wire ropes of category 1 according to ASTM A1023. Similarly, wire ropes of wire rope class „18x7“ can be compared with those of category 2 according to ASTM A1023. For very demanding lifting functions, only wire ropes of wire rope class „35x7“ or „Category 1“ should be used.

**Please note:** wire ropes of wire rope class „35x7“/ category 1 must always be replaced by equivalent wire ropes, never by wire ropes of wire rope class „18x7“/ category 2! Low-rotation wire ropes of „Category 2“ or wire rope class „18x7“, on the other hand, can also be replaced with wire ropes of „Category 1“ or wire rope class „35 x7“, which are of higher quality in terms of freedom from rotation, from a

**NOTE:** technical point of view.

In addition to the rotation-resistant wire ropes that are manufactured in accordance with national or international standards, there are many other rotation-resistant wire rope constructions that not only meet standard requirements, but also significantly higher requirements in terms of freedom of rotation. These wire ropes are truly special wire ropes, developed for the highest requirements in terms of freedom of rotation, e.g. for the highest hook heights of the most modern cranes. In order to provide the user with a general guideline for classifying such special wire ropes, the standard designations explained above are also used for these in addition to the manufacturer-specific product names, even though the performance is higher.

**IMPORTANT:** If rotation-resistant wire ropes are required, they must not be replaced by non-rotation-resistant wire ropes.

### Use of swivels for hoist wire ropes

Under certain circumstances, twist can occur in the wire rope drive. The use of a swivel can be very helpful in reducing this twist, e.g. if the deflection angle between the drum and the first sheave or between the sheaves exceeds the recommended values. In the case of multiple reeving, however, the twist catcher cannot compensate for the twist to the same extent in all wire rope strands. In this case, the twist is preferably reduced in the first wire rope strands after the twist catcher. The swivel reduces the risk of twisting the hook block, but also of wire rope damage such as corkscrewing or cage formation, which can lead to the wire rope dropping.

Please note that only wire ropes of „Category 1“ according to ASTM A1023 or wire rope class „35x7“ according to EN 12385-4 may be used both with and without a swivel.

For all other low-rotation wire rope constructions, a swivel must not be used.

Further information on the use of a swivel can be found in EN 12385-3 and ISO 21669.

### verope® range of rotation-resistant wire ropes

The verope® product range of rotation-resistant wire ropes consists of high-performance special wire ropes:

verotop P  
verotop XP  
verotop  
verotop S  
verotop S+  
verotop E

and the 4-strand low-rotation verope® wire rope construction:

vero 4

With the exception of the 4-strand vero 4 wire rope, all our wire ropes are category 1 rotation-resistant high-performance wire ropes that offer maximum freedom from rotation. All „-top“ wire ropes from verope® can therefore be used with or without a swivel. vero 4 is a very robust wire rope that has been designed for the toughest working conditions and dynamic loads, but not for freedom from rotation, only for low rotation.

Although vero 4 is a low-rotation wire rope, it must not be used with a twist arrester without being tested by an expert or after consultation with verope®.

The basic rule is that rotation-resistant wire ropes must be used for the „lifting function“. There are also exceptions here under the following conditions:

1. for „lifting function“ with a guided load, a non-rotation-resistant wire rope can also be used, as the load rotation is prevented by the frame that guides the load.

2. non-rotation-resistant wire ropes can also be used for the „lifting function“ with an unguided load if the same wire rope construction is used as a pair consisting of a right-hand and left-hand wire rope. This configuration also offers torsional stability, i.e. the load has little or no tendency to twist, as the torque generated under load is the same but acts in the opposite direction, resulting in a torque equilibrium.

**IMPORTANT:** In terms of bending fatigue performance, rotation-resistant wire ropes are clearly inferior to non-rotation-resistant wire ropes. Non-rotation-resistant wire ropes should therefore only be replaced with rotation-resistant wire ropes with extreme caution. This must be clarified with a wire rope expert.

### Other crane wire rope applications

Non-rotation-resistant wire ropes generally achieve higher bending cycles than rotation-resistant or rotation-free wire ropes. However, they exert a torque on the wire rope end connection under load. For this reason, non-rotation-resistant wire ropes can only be used if the wire rope ends are permanently secured against rotation.

Non-rotation-resistant wire ropes are always the right choice of wire rope when the „freedom from rotation“ property, which only rotation-resistant wire ropes can offer, is not required. This is the case for many wire rope applications, such as adjusting wire ropes, trolley wire ropes, holding wire ropes or assembly wire ropes.

#### NOTE:

When coupling non-rotation-free wire ropes, e.g. retaining wire ropes or grab closing wire ropes, only identical wire ropes of the same design, i.e. the same diameter, lay type and flexibility, may be used. Coupling different lay directions would untwist the wire ropes and thus destroy them.

### Use of cross and constant lay wire ropes

The selection of the type of lay must take into account the specific use of the wire rope, the wire rope construction, crane components and the expected service life of the wire rope as well as the main wear factors. The aim of wire rope selection is a long wire rope service life combined with safety, i.e. the safe operating condition of the wire rope can be reliably recognized at any time by the operator

in the specific application, taking into account the wire rope-specific discard criteria. It is therefore not possible or sensible to make a general statement on the use of cross or constant lay wire ropes without knowing the specific individual case. If you have any questions or uncertainties, please contact verope® AG.

#### Cross lay wire ropes

Cross lay wire ropes are widely used, which is why they are presumably also considered to be universally applicable. Cross lay wire ropes are very structurally stable due to the counter-rotating stranding of the wires and strands, which makes them more resistant to external twisting. The wire rope torque is lower than that of regular lay wire ropes. Cross lay wire ropes also offer good wear resistance. Due to the design, the externally visible wire breaks occur earlier than with regular lay wire ropes due to the higher pressure between the wire and the wire rope groove and the greater wire bending in the strand, which makes it easier to detect them in order to assess the wire rope condition with regard to discard maturity. Nonetheless, regular lay wire ropes are not universal wire ropes for all applications un-

der the above-mentioned wire rope selection objectives.

#### Lang lay wire ropes

Lang lay wire ropes are not only more demanding to manufacture, but also to use, starting with installation. This is due to the fact that the wires and strands are stranded in the same direction, which increases the wire rope torque and makes Lang lay wire ropes much more sensitive to any kind of external twisting.

Lang lay wire ropes achieve high breaking bending cycles due to the geometrically more favorable contact ratios between the wire and the wire rope groove, which leads to a reduction in pressure at the contact points. This reduction in pressure is beneficial for the service life of the crane components and the wire rope itself. It should also be noted, however, that the development of externally visible wire breaks is slower than with cross lay wire ropes. It can therefore be more difficult to detect discard maturity due

to externally visible wire breaks. As a result, the number of discard wire breaks in regular lay wire ropes is significantly lower than in regular lay wire ropes with an identical wire rope structure. This means that Lang lay wire ropes are not universal wire ropes for all applications with the above-

mentioned wire rope selection objectives.

#### NOTE:

As described in the section „Lang lay wire ropes“, their use can lead to increased wire breaks inside the wire rope without these being visible from the outside. This is particularly the case when using rotation-resistant wire ropes in constant lay under pure alternating bending stress and when running over plastic sheaves. This should be clarified with a wire rope expert or verope® AG.

### Crane components and crane geometry

In addition to the wire rope itself, crane components and crane geometry are important criteria for the correct wire rope selection. The drum system used and the deflection angles selected by the crane geometry must be emphasized. While single-layer wound drums subject the wire rope not only to tensile load but also to bending and lateral deflection and thus twisting, mechanical wear and transverse compressive stresses between the contacting wire rope strands dominate in multi-layer winding.

The deflection angle selected by the crane geometry is an important parameter for reliable wire rope winding and the degree of wire rope wear. A maximum deflection angle of 1.5° is recommended for multi-layer winding, while single-layer drum systems can work with higher deflection angles, e.g. up to 4°.

The correct wire rope selection must therefore be adapted to these operating and wear conditions.

The following basic rules for selecting the type of wire rope lay for wire ropes wound on drums have proven their worth and are therefore also recommended by us:

- Single-layer wound drum = cross lay wire rope
- Multi-layer wound drum = Lang lay wire rope

Sur les tambours à une couche, le câble à torsion croisée présente des avantages évidents, car il peut mieux compenser les angles de déviation généralement plus importants. La détection plus facile des ruptures de fils visibles In

the case of single-layer drums, the lay wire rope has clear advantages as it can better compensate for the usually larger deflection angles. The easier detection of externally visible wire breaks is also an important argument in favor of the use of lay wire ropes on single-layer drums, where heavy mechanical wire rope wear, which also leads to wire breaks, is not or not significantly present. In the case of multi-layer winding, it is not the alternating bending fatigue strength of the wire rope but its resistance to mechanical impact that is decisive for the service life of the wire rope. Cross lay wire ropes are less suitable for multi-layer spooling because wires of neighboring wire rope strands can get caught in each other. This leads to high mechanical wear. The contact between the wire rope strands during the winding process is also clearly „audible“.

The result is premature wire breakage. Lang lay wire ropes have therefore successfully established themselves for multi-layer winding, as no interlocking of adjacent wire rope strands in contact is possible, which significantly increases the service life of the wire rope.

By using wire ropes with compacted outer strands or hammered wire rope constructions, the wire rope service life can be further increased due to the very smooth surface and high abrasion resistance.

The above explanations have proven themselves in practice.

Deviations requested by the customer on a case-by-case basis must therefore always be thoroughly checked with regard to the specific wire rope application conditions:

- specific wire rope application conditions
- the selected wire rope construction
- as well as the customer's wire rope monitoring with regard to discard maturity

before a deviating decision can be made.

### 3.4 Technical data

Breaking forces and wire rope weights can be found in the valid „verope® general catalog“.

For further technical information, please request the technical data sheet for the verope® special wire rope you are using by sending an e-mail to [info@verope.com](mailto:info@verope.com). More general information can also be found in ISO 4309.

### 3.5 Reference to catalogs or data sheets



You can download the brochures here  
[marketing@verope.com](mailto:marketing@verope.com) | [www.verope.com](http://www.verope.com)

**WORLD OF VEROPE®  
BROSCHÜREN**

**TECHNISCHE BROSCHÜRE →**  
Leitfaden mit zahlreichen Tabellen und Grafiken mit Hintergrundinformationen zum Aufbau und Umgang mit Spezialdrähtseilen.

**SCHWERINDUSTRIE →**  
Diese Segmentbroschüre hilft Ihnen, das perfekte Seil für Ihre Anwendung auszuwählen.

**← HANDLING BROSCHÜRE**  
Hilfsmaterial mit wichtigen Hinweisen und Erklärungen, die unsere Kunden bei der korrekten und sicheren Seilhandhabung unterstützen.

**← BAUINDUSTRIE**  
Diese Segmentbroschüre hilft Ihnen, das perfekte Seil für Ihre Anwendung auszuwählen.

**GESAMT KATALOG →**  
Alle verope® Spezialdrähtseile in einem Gesamtkatalog zusammengefasst und nach Anwendungen sortiert.

**HAFENINDUSTRIE →**  
Diese Segmentbroschüre hilft Ihnen, das perfekte Seil für Ihre Anwendung auszuwählen.

**← IMAGE BROSCHÜRE GROUP**  
Die verope® Group mit ihren weltweiten Standorten stellt sich vor.

**← BORDKRANE**  
Diese Segmentbroschüre hilft Ihnen, das perfekte Seil für Ihre Anwendung auszuwählen.

**IMAGE BROSCHÜRE KV →**  
Weltweiter Technologieführer: Kiswire verope® Research & Development Center für Forschung und Entwicklung.

**OFFSHOREINDUSTRIE →**  
Diese Segmentbroschüre hilft Ihnen, das perfekte Seil für Ihre Anwendung auszuwählen.

Bestellen Sie hier Ihre Broschüre:  
[marketing@verope.com](mailto:marketing@verope.com) | [www.verope.com](http://www.verope.com)

**Fig. 26 : Brochures**

### 3.6 General information

#### Important information

Incorrect selection and use of wire ropes can be dangerous.

Protect yourself and others!

Rope failure can cause serious property damage, injury or death!

With the following information, we would like to draw your attention to some essential points for the correct selection, operation and monitoring of wire ropes. In addition to technical literature on wire ropes and national and international standards, the verope® team will be happy to assist you with any questions you may have about wire ropes. Please contact us!

- Wire ropes must be properly transported, stored, installed and maintained. Please refer to the relevant literature on these topics.
- Wire ropes must be checked for wear or damage before each use. This also applies to their end connections. Never use worn or damaged wire ropes or end connections!
- Wire ropes must not be overloaded or subjected to shock loads!
- The wire rope behavior can change significantly when exposed to very high or very low temperatures. Please discuss this with our specialists.
- End connections fitted by verope® must not be modified by the customer, e.g. by machining.
- Our products are constantly undergoing further development. The technical data may change as a result. The latest data on our website is authoritative.
- The cross-sectional images in the catalog show a typical wire rope diameter. wire ropes with smaller and larger diameters may have a different cross-section.
- Wire ropes and their end connections are not fatigue-resistant and must therefore be inspected regularly to ensure that they are in a safe operating condition. Wire ropes and their end connections must be discarded before reaching an unsafe condition. Please observe the applicable international or national standards (e.g. ISO 4309, EN 12385 and EN 13411) and the technical literature for expert inspection and correct determination of the discard state of wire ropes and their terminations.

## 4 PACKAGING, TRANSPORT, HANDLING AND STORAGE

### 4.1 Product labeling

#### CAUTION:

Incorrect handling and installation procedures can have serious consequences. Personal injury and damage to property can occur! The wire rope should be handled and stored in accordance with the usual instructions and under the supervision of a competent person.

- With regard to product labeling, please refer to the relevant contractual wire rope data sheet, label (or description), delivery bill and certificate.
- Missing or incorrect product labeling as well as a discrepancy between the certificates and the specifications of the order can lead to errors and incorrect installation!
- Make sure that the labeling on the wire rope or packaging corresponds to the corresponding certificate and delivery bill. If they do not, the wire rope or reel must be marked immediately in accordance with the delivery bill.
- Make sure that the correct wire rope has been delivered. The delivery bill, certificate and labeling, wire rope diameter, end connection, lay direction, wire rope structure, minimum breaking strength, galvanization and wire rope length must match.
- Keep the certificate in a safe place so that you can always identify the wire rope.
- Check the wire rope for damage immediately after delivery:
  - Transport damage to packaging and reel
  - Top layer of wire rope for damage such as broken wires, untwisting, kinking, etc.
- Note any damage on the delivery documents, do not use the wire rope.
- Keep the supplied declaration of conformity in a safe place for traceability purposes.

In the event of deviations or uncertainties:

Contact your distributor or verope® AG directly.

If you have any questions about the system, contact the designer/manufacturer of the machine or hoist.

## 4.2 Storage, handling & assembly

Always wear personal protective equipment and observe local regulations and risks during all of the following activities.



Use hearing protection



Use eye protection



Use foot protection



Use hand protection



Use protective clothing



Use head protection



Use safety vest



Use respiratory protection

## General instructions

### Unloading, stowing and transporting reels

Handling wire rope reels requires a certain degree of caution. The reel should therefore either be unloaded from the loading area using an industrial truck, whereby the reel is lifted using a sufficiently dimensioned shaft as an attachment point for the fork tines, or using the overhead crane as described in the picture below. The coiled wire rope

should always be moved as described below. Reels that are carelessly knocked over with the forklift can damage both the reel and the wire rope, so this is not advisable.

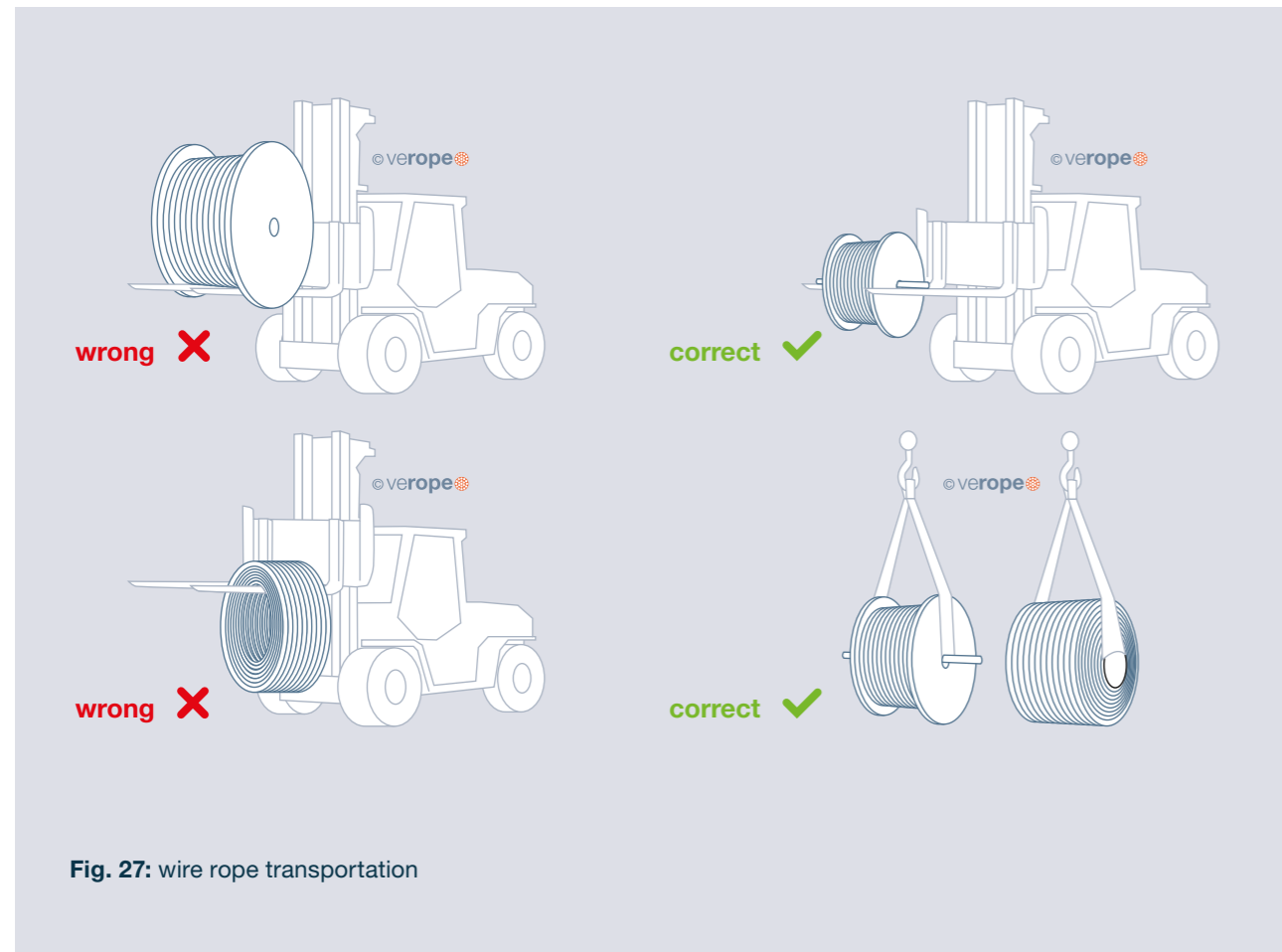
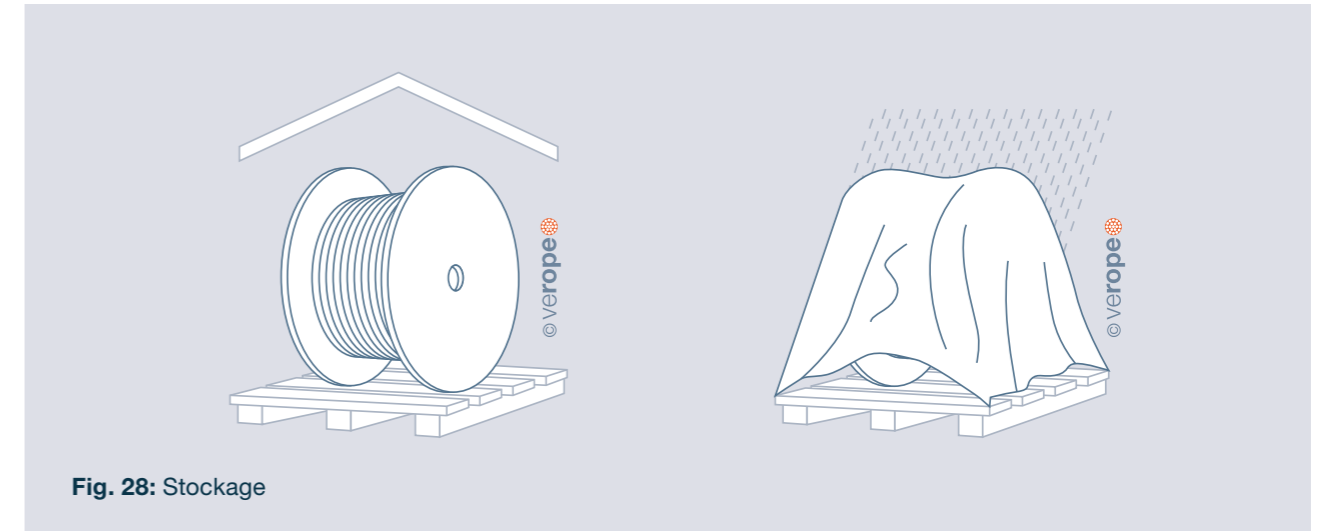

Fig. 27: wire rope transportation

### Correct storage of wire rope reels

After unloading, the reel must be stored correctly. It is important that the reel is always underlaid with a pallet to protect it from ground moisture. In addition, it should be stored in a covered area where the wire rope is protected from the weather. In any case, the reel must be protected

from rain and direct sunlight. Even if the measures described are only used for a short period of time.



### Handling the special wire rope during unwinding and rewinding processes

Suitable devices are required to spool the defined wire rope length onto a drum or to bring the wire rope into the

system. For example, turntables or winding stands (as shown in the picture) make it possible to install a wire rope.

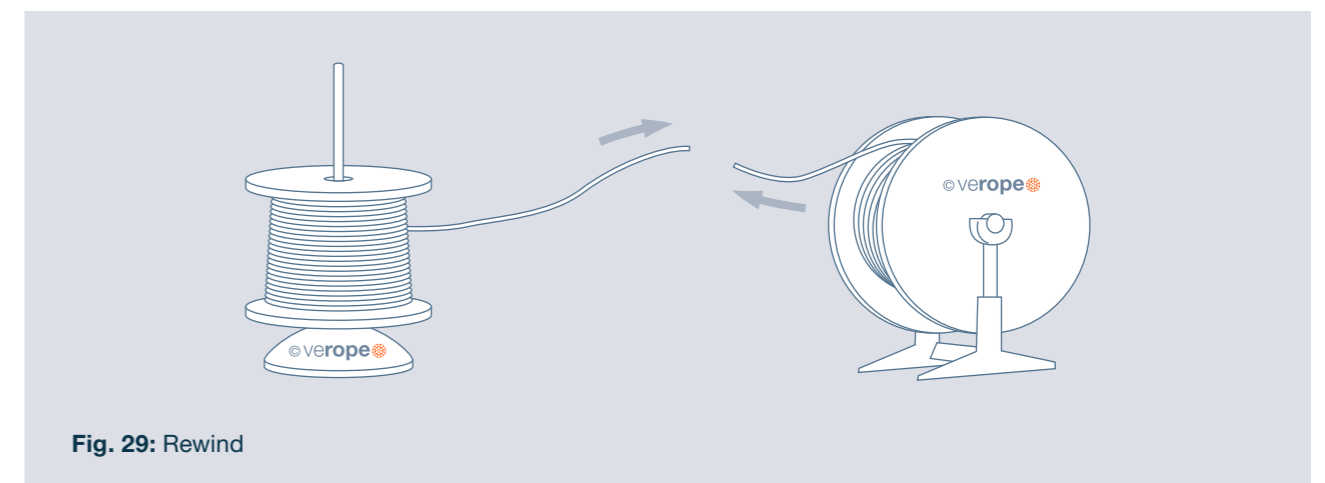

!! Take care when rewinding wire ropes due to protruding wire rope elements or trapping hands !!

For wire ropes that are spooled onto drums, it is also important that the correct spooling direction is maintained and that the wire rope is installed with pre-tension. If the wire rope is wound onto the drum from above, the wire rope must also run off the top of the reel. Crossing these

directions has negative effects that can render the wire rope unusable. Pre-tensioning the wire rope to be installed serves to ensure wire rope safety and a clean spooling pattern on the drum. This pre-tensioning is mandatory, as the wire rope can be destroyed if it is loosely coiled and working under load.

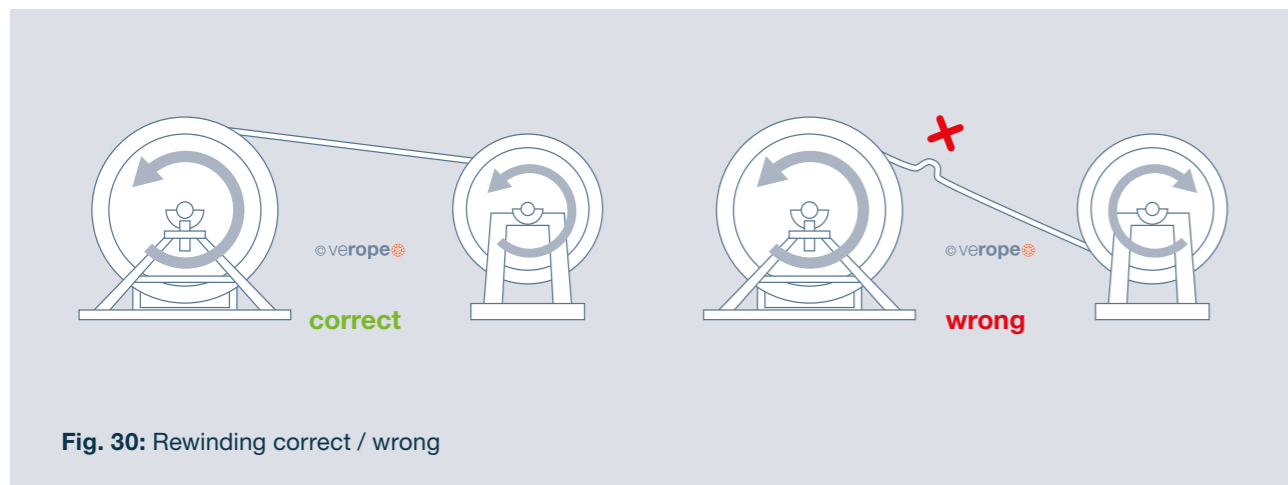

Fig. 30: Rewinding correct / wrong

According to the standard, a preload of at least 2.5 % to 5 % of the minimum breaking force should be applied. Often these values cannot be achieved with the available devices, in which case the motto „the more the better“ must

be applied. The following illustration shows the correct winding direction and a winding process in which the reel is braked.

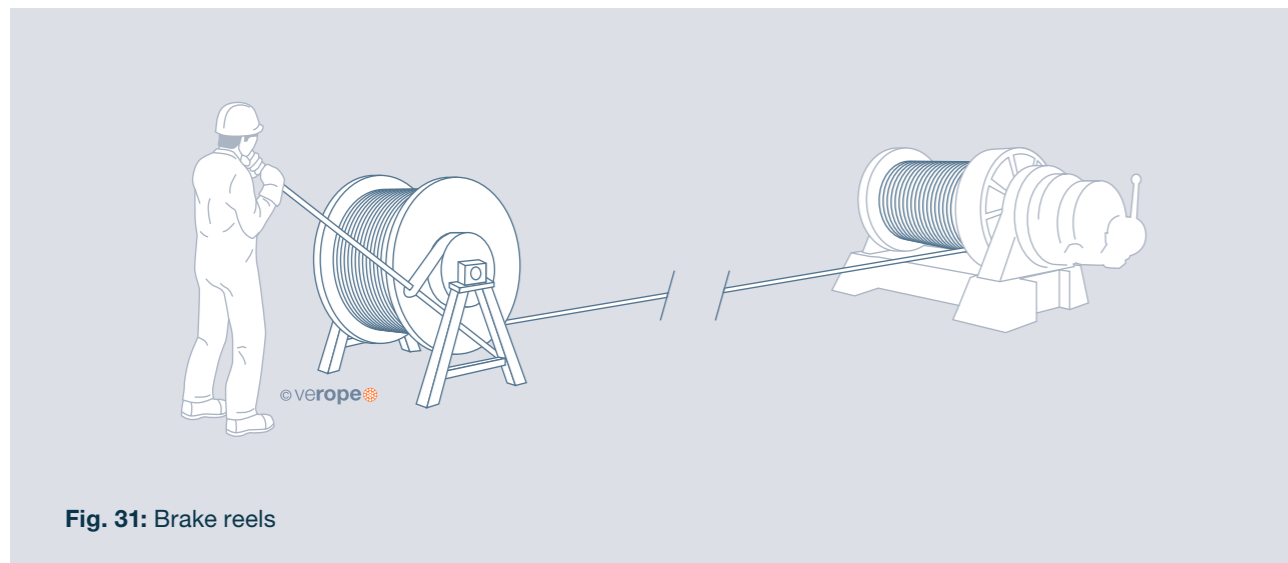

Fig. 31: Brake reels



!! Be careful when braking, hands may become trapped or slip off !!

The following pictures show the general procedures for removing or not removing the wire rope from the reel:

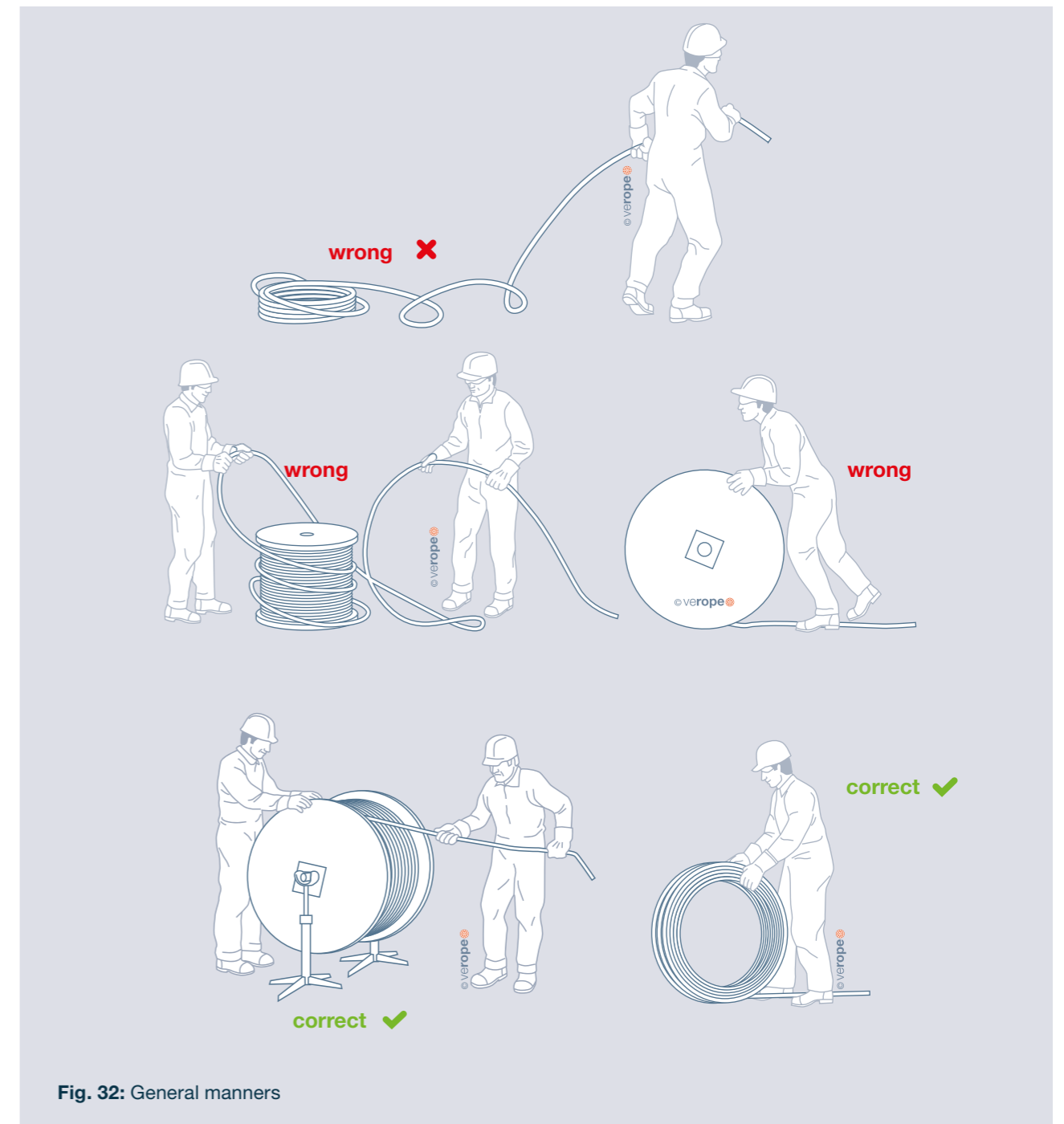

Fig. 32: General manners



!! Be careful when handling wire ropes, possible entrapment !!

How is a wire rope cut correctly?

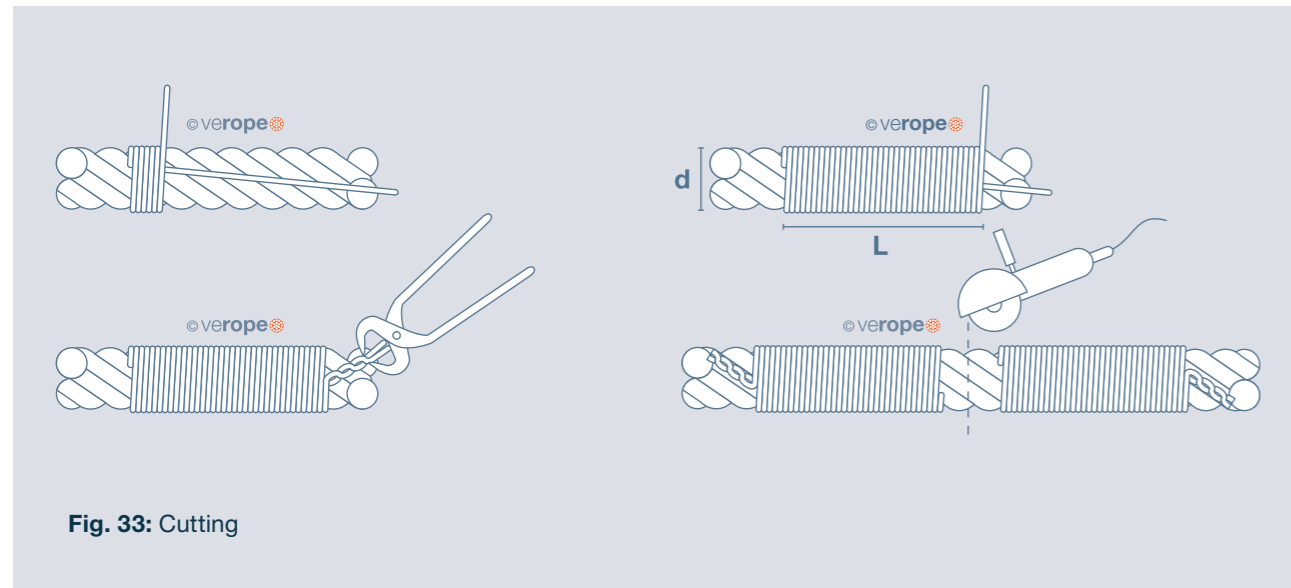

Fig. 33: Cutting



!! Be careful when cutting wire ropes, cuts and puncture injuries or jamming are possible !!



Naturally, the strands in a wire rope must follow a helix shape. This sometimes creates high tension in the individual wire rope elements. Due to these influences, wire ropes must be secured against uncontrolled unraveling. This is usually ensured by welding the ends or by attaching a suitable end connection. If you now want to shorten the wire rope to its original length, you must fix the wire rope to the right and left of the desired cutting point in accordance with EN 12385-2.

rope in accordance with EN 12385-2. The pictures below show the use of binding with stranded wire to secure the preformed wire rope against untwisting. The length of the binding is defined as follows:

$$L = 2 \times \text{nominal wire rope diameter } d.$$

For wire ropes that are not low tension, 2 fixed bindings must be placed on each side of the cut.

5. ASSEMBLY



Always wear personal protective equipment and observe the hazards when carrying out the following activities.

5.1 Installation instructions

General installation instructions

Ropes must be replaced due to their limited service life, which is normally significantly shorter than the service life of the system. The installation process differs between the va-

rious systems on which the wire rope is installed. However, the following instructions should be observed regardless of the type of system:

- Avoid counter-bending, observe unwinding and rewinding direction
- Observe the distance between the first incoming wire rope sheave and the outgoing wire rope reel (1000 x nominal wire rope diameter)
- Always use a swivel between the pull-in wire rope and the new wire rope.

If these points are observed, some wire rope damage and consequential damage can be avoided in advance.

Rope installation: wire rope installation must be carried out with the necessary caution and work safety when installing a wire rope. Before installing the wire rope, check that the wire rope construction and the direction of lay are correctly aligned with the winch drum and the wire rope system. The condition and dimensions of the wire rope grooves in the drums and sheaves must be checked to ensure that the requirements of ISO 16625 are met. If the new wire rope is pulled in with an auxiliary wire rope of smaller diameter, a rotation-resistant wire rope construction or a synthetic auxiliary wire rope with high rotational stability should be selected. If the new wire rope is pulled in with the old wire rope, a mounting eye should

be welded to the wire rope ends in order to connect them securely to a strand or a thinner wire rope. Twists from the old wire rope can be transferred to the connecting strand or the thinner connecting wire rope during the pulling-in process without damaging the new wire rope. wire rope socks are often used to pull in wire ropes. To ensure safe use of these wire rope socks, the wire rope ends held by the wire rope socks should be wrapped with a bind-off. This increases adhesion and prevents possible slipping. A strand or a wire rope with a smaller diameter can be used as a connecting wire rope.

5.2 Installation

New wire rope and old wire rope with the same diameter

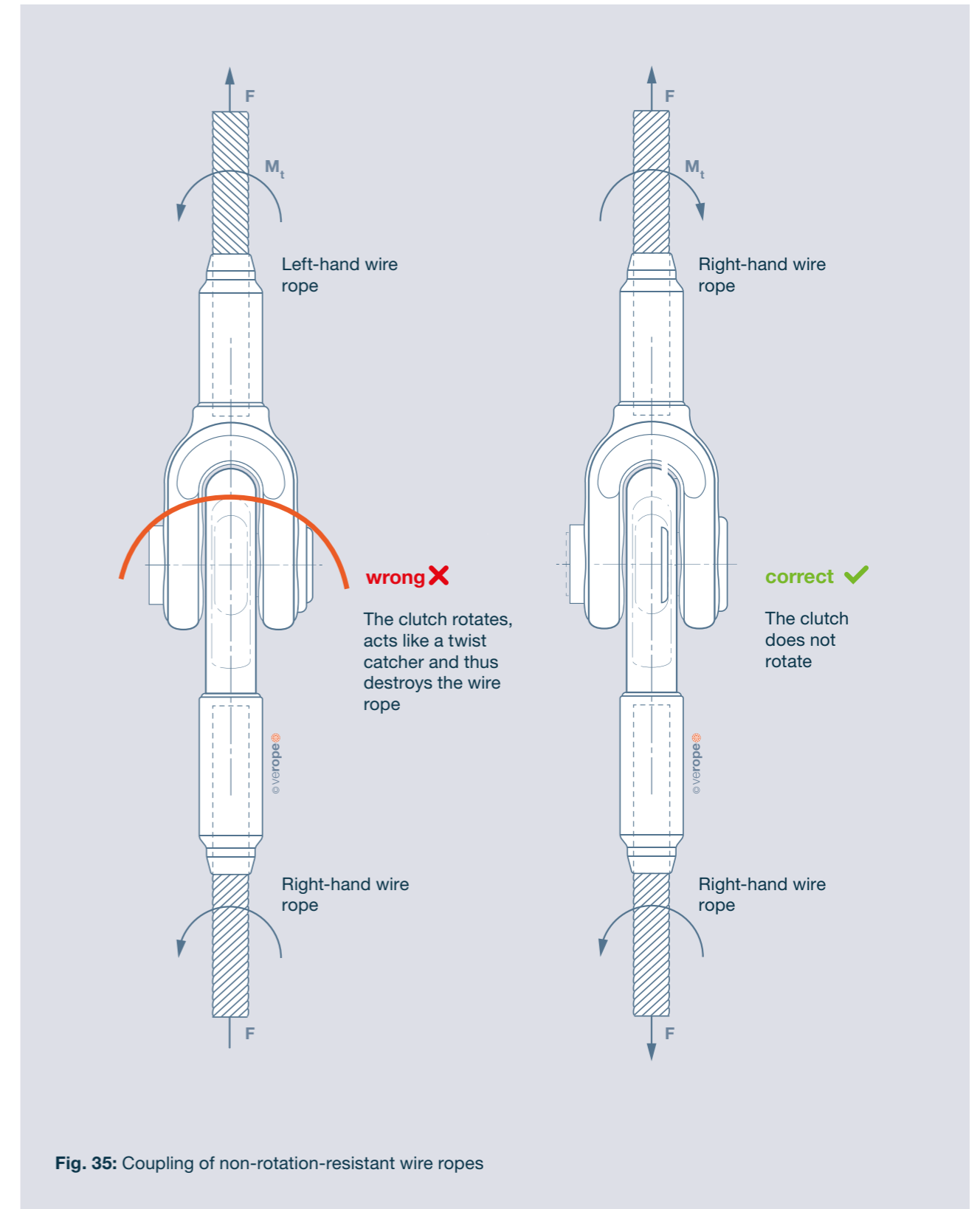
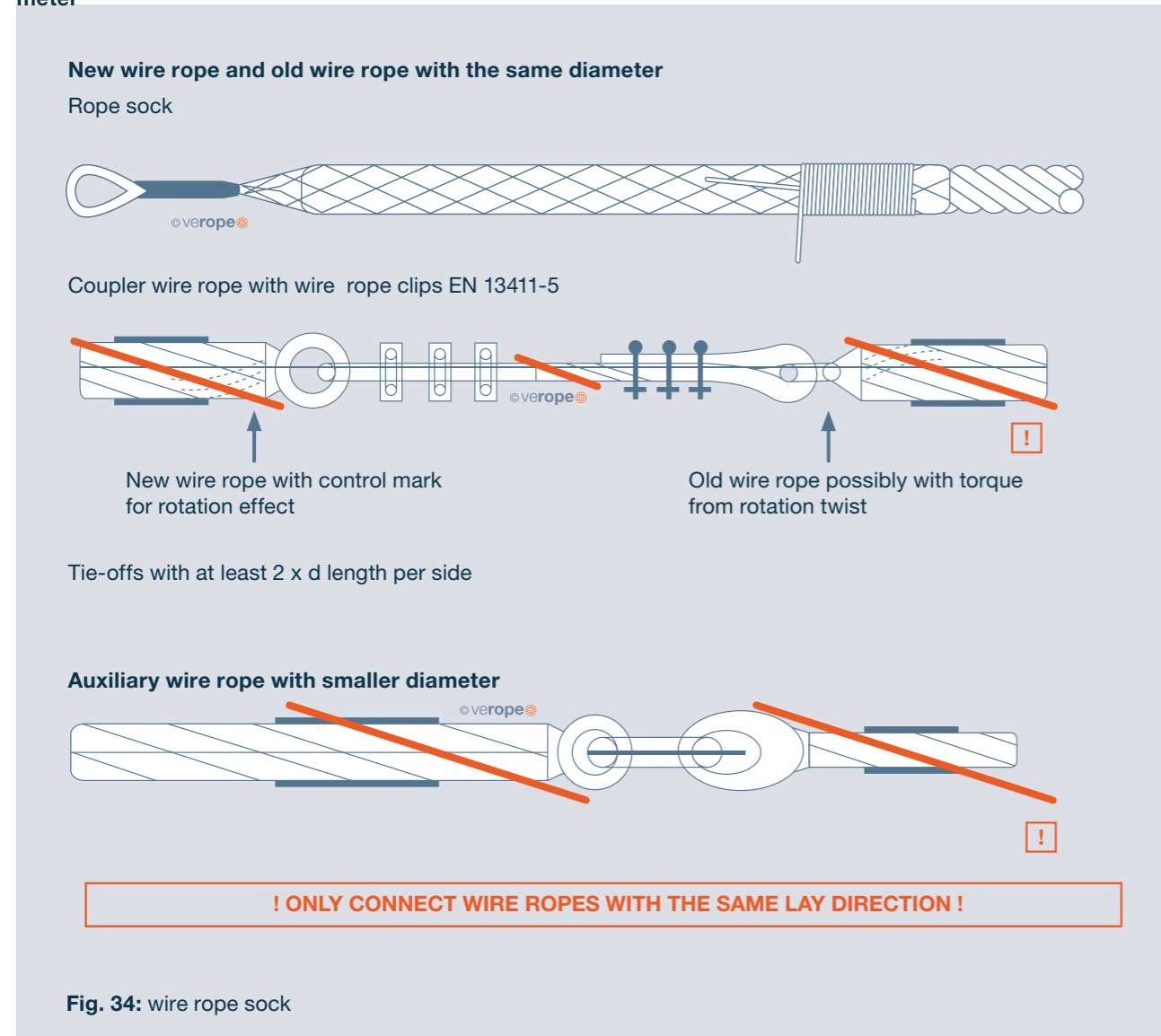

## Rope installation

The wire rope installation must be prepared as well as possible. The following points must be observed:

### Notes

- If possible, do not guide the wire rope with your hands
- Observe national work and product safety regulations
- Clearly mark or cordon off the work area
- Guide or secure the wire rope in such a way that tripping hazards are prevented
- Do not lay out the wire rope in traffic and footpaths

### Checking the new wire rope

The new wire rope must be checked with regard to construction and lay direction, and the current wire rope diameter must be measured. This information should be compared with the delivery documents. The following diagram shows the correct assignment of the wire rope rotation, right-hand or left-hand wire rope, to the existing drum, which winds the wire rope up or down. Drums can

be divided into right-handed and left-handed. The tried and tested rule for selecting the correct wire rope is that a right-handed wire rope is used on a left-handed drum and vice versa. This applies in particular to all single-layer drum systems. We also recommend observing this rule for multi-layer winding drums.

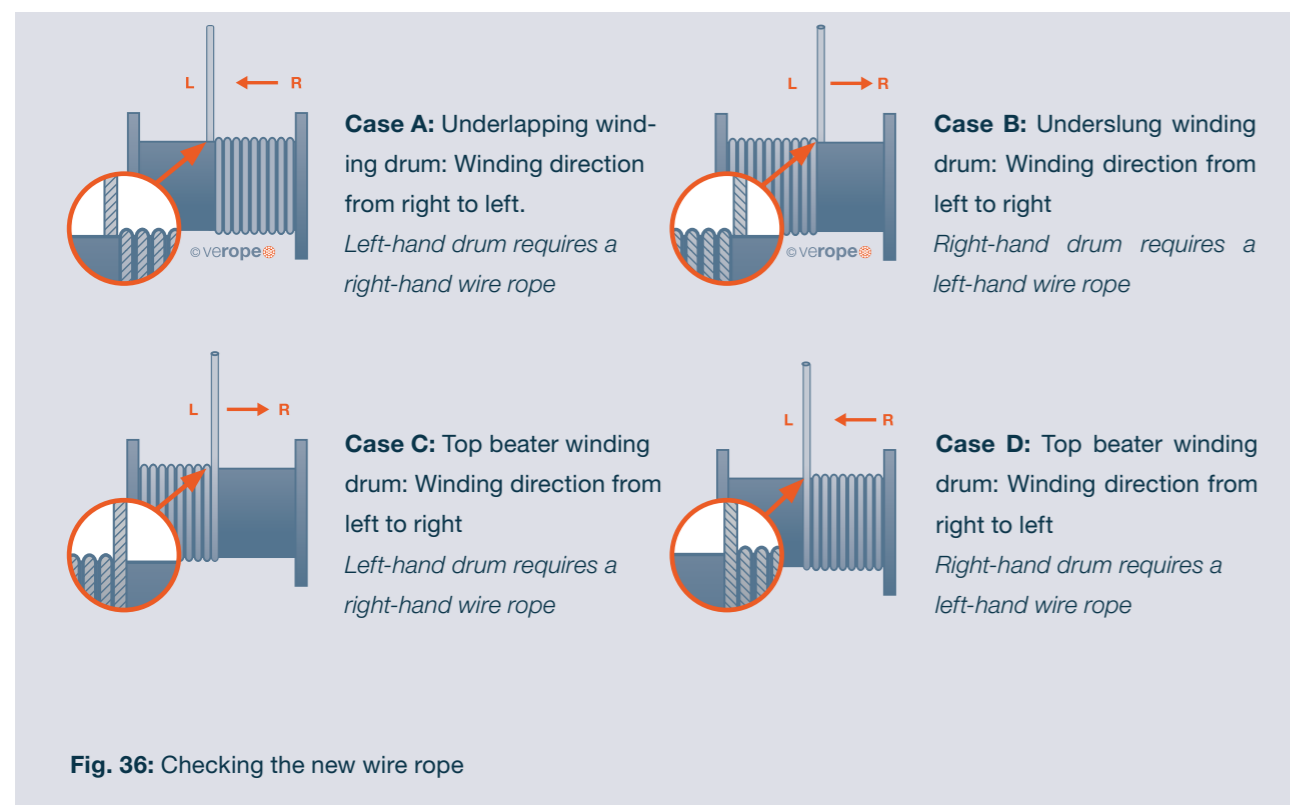

### Disassembly

- Improper disassembly can lead to injuries
- Ropes may only be dismantled by appropriately qualified personnel.

## 5.3 Installation examples



### Deck crane installation example

#### The installation process

The most advantageous way to install a wire rope varies from crane to crane. In any case, a method should be selected that can produce the least risk of wire rope twisting or damage to the wire rope (at a reasonable cost). If you unwind the wire rope from the delivery reel, the delivery reel must be designed to rotate. Unwinding the new wire rope from a stationary reel or non-rotating reel will cause the wire rope to twist and the wire rope can be destroyed during installation. With some cranes, it may be advisable to remove the old wire rope first and then install the new wire rope. On other cranes, especially larger cranes, it may be better to attach the new wire rope

to the old wire rope and pull it in.

Another option is to use a thinner wire rope as a pull-in wire rope, which is then used to pull the actual wire rope into the system later. This method is often used on new devices. In any case, careful consideration should be given to whether the wire rope should be pulled through the entire reeving system or whether it should first be wound from the reel onto the drum and then pulled into the system.

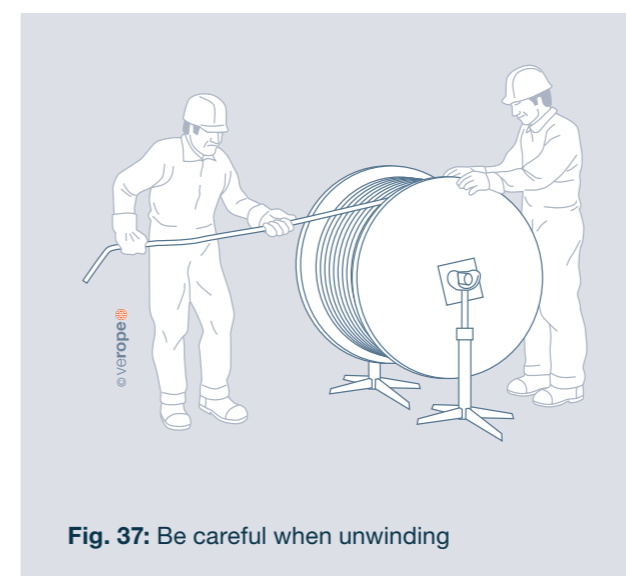

!! Be careful when rewinding, hands can be pinched !!

### Typical example of a deck crane

An example of a typical deck crane is shown on the right, in which the wire rope is pulled from the wire rope reel over the wire rope sheaves into the reeving and wound onto the wire rope drum. It must be ensured that the wire rope surface is clean and that no sand or dirt adheres to the wire rope lubricant. A dirty wire rope can damage the wires when running over the sheaves and significantly reduce the effectiveness of the lubricant.

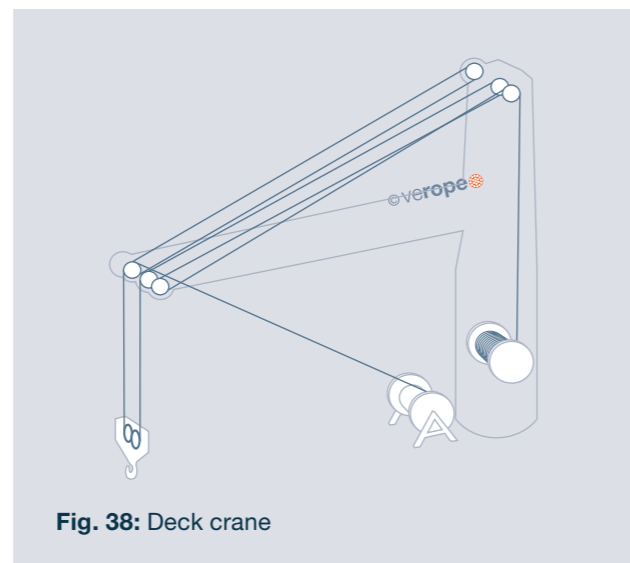

Fig. 38: Deck crane

### Installing the new wire rope using the old wire rope or a thinner wire rope

If the new wire rope is pulled by the old wire rope or by a thinner wire rope, it must be ensured that the connection between the wire ropes is absolutely secure. It must also be ensured that the thinner wire rope cannot rotate or twist. For example, rotation-resistant wire ropes must be pulled in using the same rotation-resistant wire ropes or four-strand wire ropes with low rotation resistance. When installing non-rotation-resistant wire ropes, it must at least be ensured that the new and old wire ropes have the same lay direction. In all cases, it is helpful to fit a small wire rope swivel between the wire rope ends to remove any possible

twist. If the new wire rope is pulled in with the help of the wire rope used, the two wire rope ends are often blocked. Such a connection can transfer the twist of the old wire rope, which is in the system, to the new wire rope. This type of installation can damage the new wire rope even before it is used for the first time. There are other reasons why this method is very problematic: when using welded mounting eyes, these can be overloaded by the twisting forces and break.

### Attaching the wire rope end connection to the fixed point

After the wire rope has been pulled through the reeving, the wire rope end connection must be brought to the fixed point. Using a chain hoist, the wire rope end connection can be pulled up to the fixed point and secured there with a bolt. Before fastening, the wire rope end connection can

be precisely aligned with the fixed point using a steel rod. The rod should be attached to the wire rope with a short chain. Under no circumstances should the wire rope be gripped with a wrench or pliers, as this could damage the outer wires.

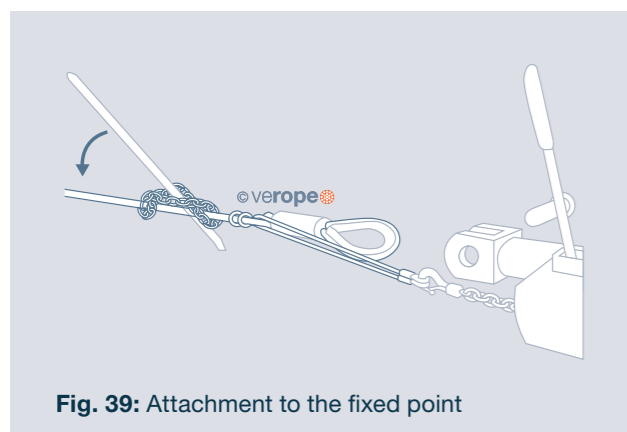

Fig. 39: Attachment to the fixed point



!! Take care when releasing fixed points, wire rope ends can fall over !!

### Working in the new special wire rope

After the wire rope has been installed and before it fulfills its task, several runs of the normal operating sequence should be carried out under light load. The new wire rope should be „worked in“ so that the elements can settle and adapt to the actual operating conditions. Unfortunately, the exact opposite often happens in practice. It is not uncommon for overload tests to be carried out after the wire rope has been installed with loads that exceed the normal working load of the system. As a result, the wire ropes are not adapted to the operating conditions and uncontrollable tensions or twists can form in the wire rope.

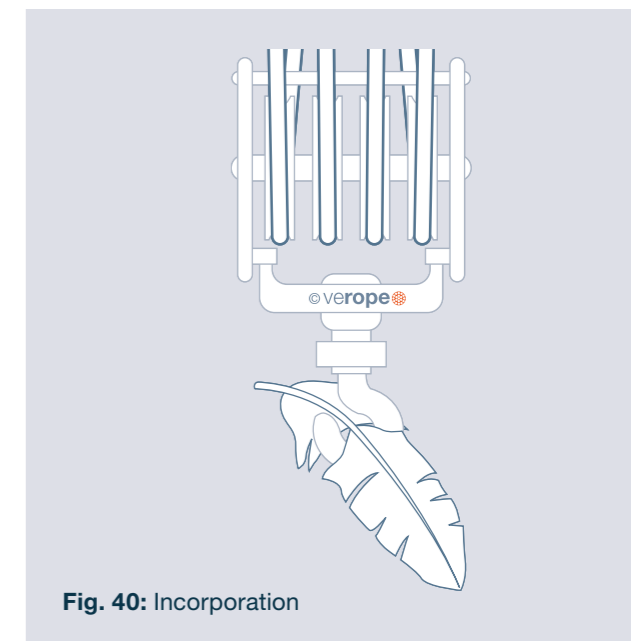

Fig. 40: Incorporation

**Mobile crane installation example**

Many crane manufacturers work with special wire rope diameter tolerances. These must always be observed in order to achieve the best wire rope performance.



**Winding on the new wire rope**

If you unwind the wire rope from the delivery reel, the delivery reel must be designed to rotate. Pulling the new wire rope off a stationary reel or non-rotating reel will cause the wire rope to twist and the wire rope can be destroyed during installation. It must also be ensured that the wire rope surface remains clean and that no sand or dirt adheres to the wire rope lubricant. A dirty wire rope will damage the wires when the wire rope runs over the

sheaves. The following illustrations show the correct and incorrect way to unwind a wire rope. Special care must be taken to ensure that the wire rope does not come into contact with parts of the steel structures or other fixed parts. The deflection angle between the delivery reel and the first pulley of the crane must not exceed 2°.

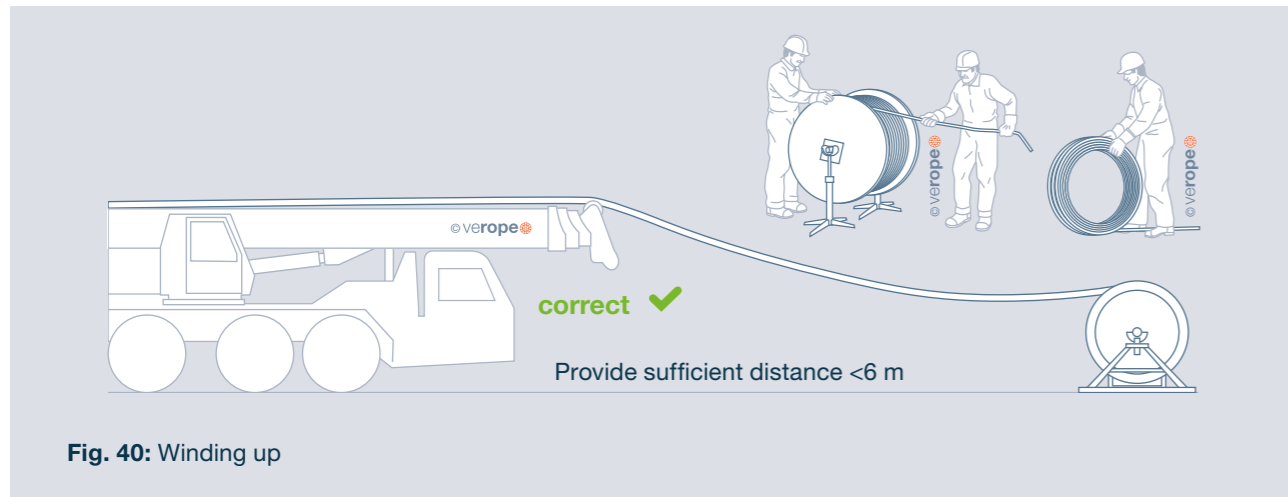

Fig. 40: Winding up

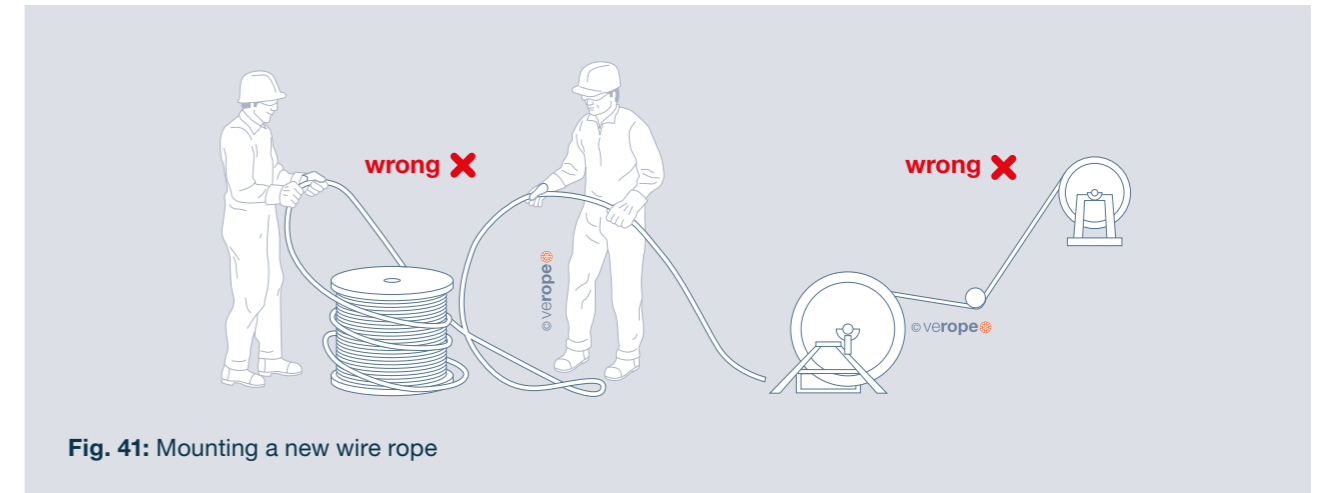

Fig. 41: Mounting a new wire rope



!! Be careful when rewinding, hands can be pinched !!

**Spooling the wire rope onto the drum**

Ensure that the wire rope is sufficiently pre-tensioned on the drum for wire rope installation. Renew the pre-tension at regular intervals so that all wire rope layers can work together firmly as a „package“. This can be done in the field as follows: Extend the boom far enough or reeve high enough so that you can unwind the entire length of wire rope up to the 3 safety windings on the drum. Now lift a sufficient load so that the wire rope is spooled with sufficient pre-tension of at least 2.5% of the MBL or 10% of the SWL from the first drum position. This procedure is also necessary if the crane has only worked with a part of the

total wire rope length. The starting and stopping movements of the drum cause the wire rope layers to shift on the lower layers and become loose. If the pre-tension of the wire rope on the drum is too low, the individual layers become loose and the wire rope strands running under tension can be pulled into the loose drum layer. This causes the wire rope to be crushed and severely damaged.

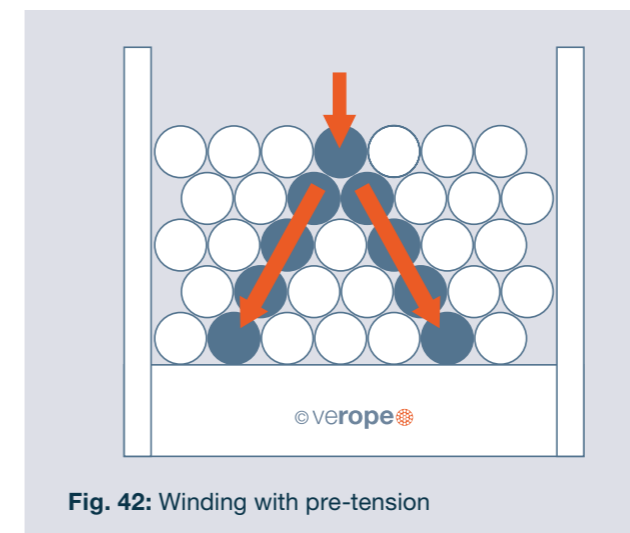

Fig. 42: Winding with pre-tension

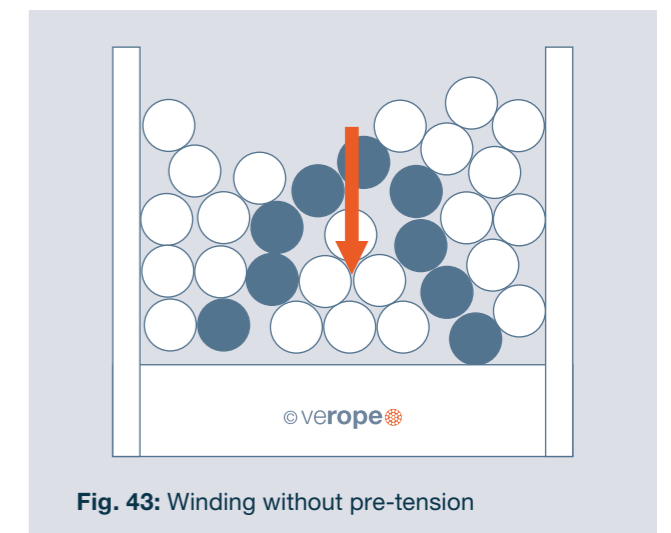
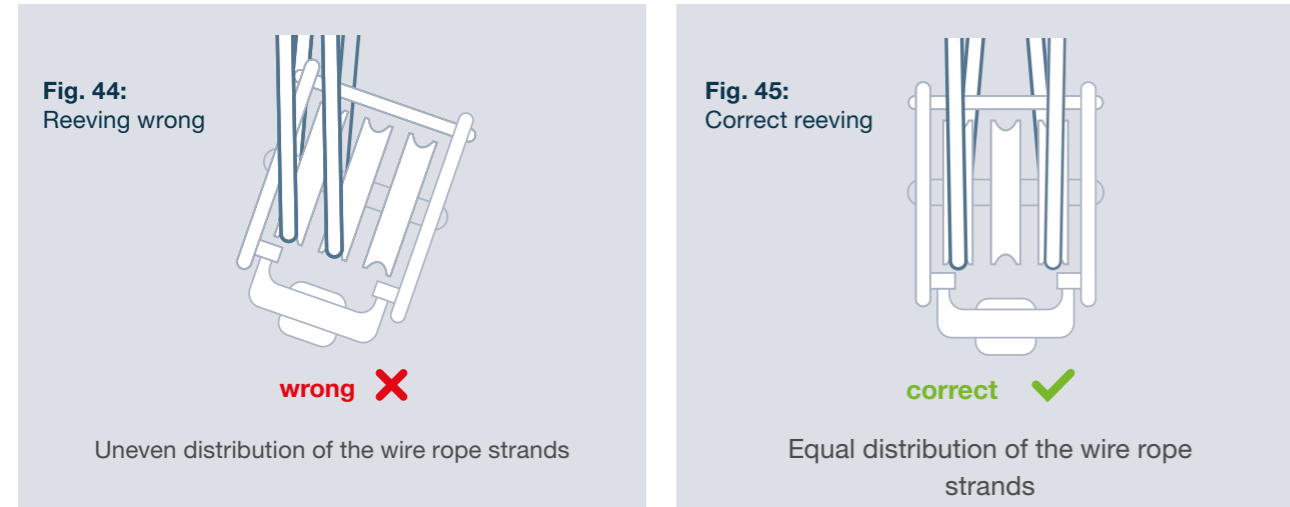

Fig. 43: Winding without pre-tension

### 5.3 Problem solving

#### Rope reeving and wire rope twisting

When reeving the wire rope, ensure that the strands are evenly distributed in the hook block. If the reeving is unevenly distributed, the hook block will be skewed and the wire rope will twist.



#### Twisting of the hook block

There are several reasons why a hook block can twist:

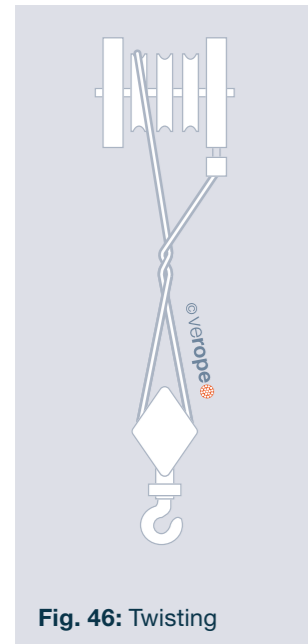

1. The reeving of an odd number of wire rope strands is significantly less stable than the reeving of an even number of wire rope strands. A 3-strand reeving is less stable than a 4-strand reeving.
2. A torque or wire rope twist was applied to the wire rope during installation. The maximum permissible deflection angle of  $2^\circ$  was often exceeded here.
3. The load center of gravity is not under the hook
4. Incorrect or uneven attachment when using a double hook.
5. Inclined or poorly balanced hook block.
6. Worn or too narrow groove profiles on the wire rope pulleys.
7. Poor wire rope lubrication or relubrication.
8. Diagonal pull during load suspension ( $>2^\circ$ ).
9. Incorrect reeving of the wire rope with deflection angles  $>2^\circ$ .
10. Skewed position of the crane.
11. Handling operation (always the same activities with a high number of repetitions).



### Untwisting of twisted wire ropes with rotation-resistant wire ropes

#### Method A:

Detach the end of the wire rope from the fixed point. Rotate the wire rope end in the opposite direction to the direction of rotation of the hook block. If the hook block rotates by  $1/2$  turn, rotate the wire rope end by  $180^\circ$ . If the hook block twists 3 full turns, turn the end of the wire rope around itself 3 times against the direction of twist of the hook block. Reattach the wire rope end and guide the wire rope (without load) through the entire reeving by lifting the hook block. This distributes the twists over the entire length of the wire rope and significantly reduces them. If the hook block still twists, the procedure must be repeated.

#### Method B:

When using rotation-free wire ropes such as verotop, verotop S or verotop E, a wire rope swivel can also be installed between the fixed point and the crane. This swivel absorbs possible twists or eliminates twists that are already in the wire rope. Once the twist has been removed from the wire rope, the swivel can be blocked, completely removed or remain permanently installed. After installing a new wire rope, the wire rope should be moved several times under low load and at reduced speed with the boom fully extended. Repeat this several times with increasing load and speed. This allows the wire rope to adapt to the working conditions and all strands and wires to settle into a neutral position. Ideally, you should loosen the end of the wire rope again after the running-in period to release any torques and twists that have built up during installation and the running-in period.

**If you have any questions, uncertainties or problems, please contact verope® AG**

#### Commissioning

Commissioning may only be carried out by trained personnel.

#### Running in the new wire rope – ISO 4309

Before fully commissioning the wire rope on the crane, it must be ensured that all hoist limiting and display devices for crane operation are working properly.

To allow the wire rope components to adjust better to the normal operating conditions, the crane should be operated at a reduced speed and load for a certain number of operating cycles [i.e. at approx. 10 % of the maximum wire rope pull or the maximum load capacity of the machine].

## 6 INSPECTION AND PERIODIC MAINTENANCE

Personal protective equipment must be worn for the following work and local safety regulations must be observed.



### 6.1 Types of inspection

#### The right wire rope inspection

##### Why inspect wire ropes?

Ropes in wire rope drives are open gears that are exposed to external influences, but also have common signs of wear. Above all, however, wire ropes have a limited service life. When the wire rope reaches discard maturity, it has also reached the end of its service life. wire rope discard must be detected in good time in order to avoid accidents such as wire rope breakage. This detection requires regular wire rope inspections that document the percentage of the wire rope used that is already ready for discarding.

##### A meaningful wire rope inspection should take the following points into account:

- General visual inspection (points requiring increased attention)
- Diameter measurement with a suitable tool and at various points - Measurement of the wire rope lay length
- Assess the degree of corrosion (if present)
- Inspect and classify the most stressed wire rope zone for wire breaks
- Measure the groove diameters in the wire rope drive
- Assess the amount of lubricant on the wire rope surface

Such inspections must be carried out regularly, although the intervals between the various points may vary. A visual inspection should be carried out daily, but the diameter should be measured monthly or quarterly, depending on the load. In principle, the current standards such as ISO 4309 should be followed.

#### General visual inspection and daily visual inspection

A general visual inspection, which must be carried out by the crane driver or system operator, is intended to detect obvious damage such as broken strands or faults in the reeving at an early stage and, if possible, to rectify them

before operation commences. Areas near the end connection and wire rope zones that could come into contact with the crane structure and the wire rope drum must be inspected with increased attention.

#### Regular inspection

The regular inspection must be carried out by a competent person. The entire crane system should be monitored and maintained.

#### Examples from practice

- Measurements to be carried out quarterly: Diameter and lay length
- Annual measurements: Groove size, sheave depth, hardness of sheaves and drum (optional)

### 6.2 Tools required for the inspection

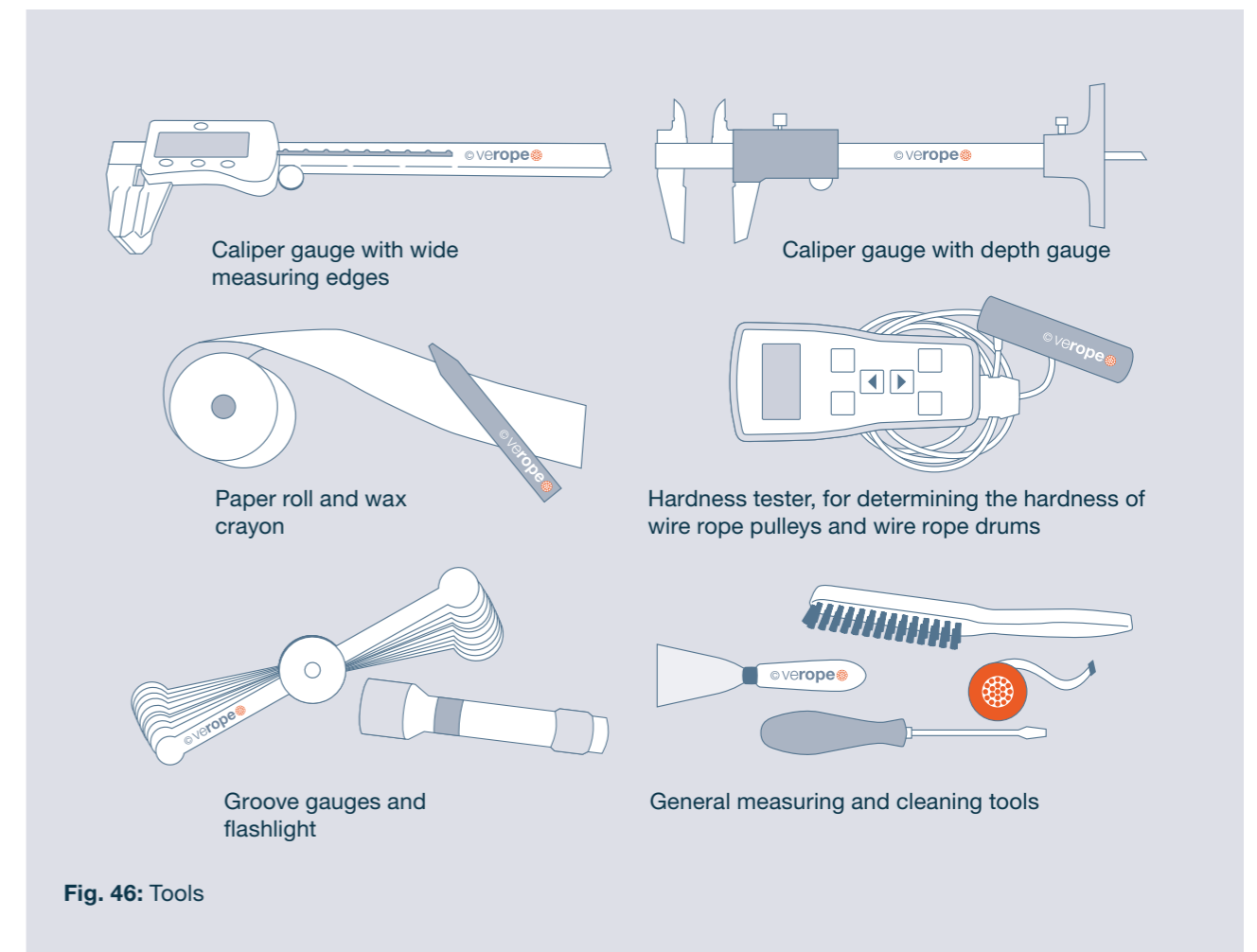

### 6.3 Discard criteria

#### Wire breaks on the wire rope surface

Wire breaks on the wire rope surface can be caused by bending stress on the wire rope when running over sheaves or wear. The number of wire breaks must not exceed a certain number over a defined length, otherwise the wire rope has reached discard maturity.



!! Protruding wires can lead to injuries !!

Wire breaks due to bending fatigue stress can multiply quickly and occur randomly.

#### Number of permitted wire breaks for non-rotation-resistant wire ropes

verope® special wire rope construction	Nominal rope diameter d (mm) <sup>7</sup>	Number of outer strands	Number of load-bearing wires in the outer strands	Rope category RCN according to ISO 4309	Stripping wire breaking number according to ISO 4309 <sup>1</sup>					
					For applicable rope ranges see footnote <sup>2</sup>				For applicable rope ranges see footnotes <sup>3,4</sup>	
					Classes M1 to M4 or class unknown <sup>6</sup>				All classes M1 to M8	
					Cross stroke		Equal stroke		Cross and equal stroke	
					over a length of				over a length of	
6 x d <sup>5</sup>	30 x d <sup>5</sup>	6 x d <sup>5</sup>	30 x d <sup>5</sup>	6 x d <sup>5</sup>	30 x d <sup>5</sup>					
verostar 8 veropro 8 verosteel 8	6 to 7	8	136	3	4	8	2	4	8	16
	8 to 42	8	208	9	9	18	4	9	18	36
	43 to 48	8	248	11	10	21	5	10	20	42
	larger 48	8	288	13	12	24	6	12	24	48
veropower 8 veropro 8 RS	up to 40	8	208	9	9	18	-	-	18	36
	41 to 46	8	248	11	10	21	-	-	20	42
	larger 46	8	288	13	12	24	-	-	24	48
verotech 10 veropro 10	larger 10	10	260	11	10	21	5	10	20	42
veropro 10	larger 49	10	310	-	12	24	6	12	24	49
verotech 10	6 to 9,5	9	153	4	5	10	2	5	10	20
	10 to 16	9	234	10	10	19	5	10	20	38

#### Number of permissible wire breaks for rotation-resistant wire ropes

verope® special wire rope construction	Number of outer strands	Number of load-bearing wires in the outer strands	Rope category RCN according to ISO 4309	Stripping wire breaking number according to ISO 4309 <sup>1</sup>			
				For applicable wire rope ranges see footnote <sup>2</sup>		For applicable wire rope ranges see footnotes <sup>3,4</sup>	
				over a length of		over a length of	
				6 x d <sup>5</sup>	30 x d <sup>5</sup>	6 x d <sup>5</sup>	30 x d <sup>5</sup>
				vero 4	4	144	22
verotop XP	16	96	23-1	2	4	4	8
verotop verotop S verotop S+ verotop E	16	112	23-2	3	5	5	10
verotop P	18	126	23-3	3	5	6	11

Tables do not apply to special wire rope constructions. Please contact verope® directly for wire rope constructions that are not included.

#### Degree of corrosion

Ropes that work in certain environments or have an increased service life begin to corrode. A distinction is made between different degrees of corrosion. ISO 4309 provides a generally applicable differentiation.

#### Guideline for the assessment and classification of external corrosion

##### Guideline for the assessment and classification of external corrosion



1. Beginning oxidation of the surface, can be washed off, only on the surface. Classification: 0 % of the discard maturity.



2. wires feel rough, general oxidation of the surface. Classification: 20 % of the discard maturity.



3. Surface heavily oxidized. Classification: 60 % of the discard maturity.



4. Surface badly pitted, wires without tension, gaps between wires. Immediate storage.

Fig. 46: Corrosion

#### Diameter reduction

The wire rope diameter of a working wire rope is constantly reduced over its entire service life. This reduction in diameter is caused by abrasion and wear and is assessed according to the following table and classified up to the point of discard.

Rope type	Uniform reduction in diameter (expressed in % of the nominal diameter)	Classification of the degree of severity	
		Description	%
Non-rotation-resistant wire ropes	less than 3.5 3.5% or more, but less than 4.5 4.5% or more, but less than 5.5 5.5% and over, but less than 6.5 6.5% and over, but less than 7.5 <b>7.5% and over</b>	—	0
		light	20
		medium	40
		high	60
		very high	80
		<b>Discard maturity</b>	100
Rotation-free wire ropes	less than 1% 1% or more, but less than 2% 2% or more, but less than 3% 3% or more, but less than 4% 4% and more, but less than 5% <b>5% or more</b>	—	0
		light	20
		medium	40
		high	60
		very high	80
		<b>Discard maturity</b>	100

The following formula is used to determine the diameter reduction:

$$\Delta d = \left[ \frac{d_{ref} - d_m}{d} \right] \times 100 \%$$

Example:

A non-rotation-resistant wire rope with a nominal diameter of 22.00 mm has a reference diameter (rope diameter in new condition) of 22.80 mm and a measured diameter of 21.90 mm.

The following applies:

$$\left[ \frac{22,80 - 21,90}{22} \right] \times 100 \% = 4,1 \%$$

The wire rope has reached 20 % discard maturity after diameter reduction.

**Inspection report:**

The ISO 4309 inspection report provides helpful support. This report lists all the relevant points of a structured wire rope inspection.

Another way to document the wire rope inspection is in the verocheck app. To do this, download the app from the App Store and contact your verope® contact person for approval.

Information on the crane:						Rope application:					
Details of the wire rope: Brand (if known): Nominal diameter (mm): Type: Core <sup>a</sup> : IWRC FC WSC Wire surface <sup>a</sup> : bright galvanized						Laying direction and type <sup>a</sup> : (right hand side): sZ ZZ Z / (left hand side): zS sS S Permissible number of outer wire breaks: 6 d 30 d Reference diameter (mm): Permissible diameter reduction from reference diameter (mm):					
Hang-up date:						Discard date:					
Visible outer wire breaks		Diameter				Corrosion	Damage and / or deformation			Position in the wire rope	Overall assessment, i.e. combined severity classification <sup>a</sup> at the position entered
Quantity in length from		Severity classification <sup>b</sup>		Measured diameter	Actual reduction compared to Reference diameter	Severity grading <sup>b</sup>	Severity grading <sup>b</sup>	Severity grading <sup>b</sup>	Type		
6 d	30 d	6 d	30 d	in mm	in mm						
Further remarks:											
Performance on the date indicated (cycles, hours, days, months, etc.):						Date of inspection:					
Name of competent person:						Signature:					
<small><sup>a</sup> If applicable, check the box    <sup>b</sup> Description</small>											

Fig. 47: Inspection report

**6.4 Other wire rope damage**

**Miscellaneous wire rope damage**



Fig. 48: wire rope damage

Rope deformations can lead to injuries!



Further information on inspecting the system can be found in the brochure „Correct handling of verope® special wire ropes“ or ISO 16625.

## 7 MAINTENANCE



Personal protective equipment must be worn for the following work and local safety regulations must be observed.

### 7.1 Maintenance of the wire rope

Maintenance of the wire rope must be carried out taking into account the crane type, frequency of use, environmental conditions and wire rope type.

During its service life and before it shows any signs of dryness or corrosion, the wire rope must be relubricated as specified by a competent person for wire rope inspection, in particular by a qualified wire rope inspector.

The wire rope must be relubricated during its service life and before it shows any signs of dryness or corrosion, as determined by a competent person for wire rope inspection, especially in the zones that run over sheaves, run onto or off the drum, or the sections that run over compensating sheaves.

For more information, refer to ISO 4309.

### 7.2 Relubrication of special wire ropes



!! Take care when relubricating by hand, Hands can get jammed or caught !!

#### Types de lubrifiants

In principle, verope® uses two types of lubricants, namely wax-based and oil-based agents. The choice of basic lubricant depends on the application, wire rope type and place of use. There are also lubricants that are used in areas with special requirements such as water solubility, drip resistance or nature conservation guidelines. The range of lubricants is just as diverse as the various applications. In order to increase the service life of the wire rope and protect the inside of the wire rope, the lubricant film on the wire rope surface must remain constant. Lubricant

is usually lost during operation and must be reapplied at regular intervals. When selecting a suitable relubricant, the existing base lubricant must be used, as otherwise compatibility problems may occur. If you are unsure which lubricant your verope® special wire rope uses, we will be happy to advise you.

### Quantity and frequency of relubrication

We generally recommend relubricating the wire rope 10 times over its entire service life. For applications that have a comparatively short service life (e.g. due to high and rapid wear), the wire rope must be relubricated 10 times after

use. relubrication as required. The quantity of relubricant to be applied can be defined by the following equation:

$$\frac{\text{Rope weight} \frac{\text{kg}}{\text{m}} \times \text{wire rope length} \times \text{lubricant}}{100} = \text{quantity kg}$$

### Preparing the wire rope to be relubricated

The wire rope must be prepared so that the relubrication and the newly applied preservative can fulfill their full function. Applying the lubricant without prior treatment covers the existing lubrication, which has often dried out and no longer has any lubricating effect. In addition, a wire rope that is free of surface dirt is easier to inspect so that possible defects are easier to detect. There are various ways to remove the existing lubricant from the wire rope surface. There is a cleaning system that uses rotation and translation to remove the dirt from the wire rope surface. Another conventional method of removing the lubricant from the wire rope surface is the use of steel wire brushes.

Here, the lubricant is scraped off the wire rope surface by relative movements on the wire rope surface. The more lubricant is removed from the surface, the better the effect of the new lubricant. This method requires a great deal of force and is very time-consuming, depending on the length of the wire rope. Nevertheless, this procedure is very effective if no other method is available.

### Application of the relubricant and the different methods

Once the old lubricant has been removed from the wire rope surface, the new lubricant is applied. Various methods and procedures can also be used here. There are various companies that offer complete solutions for re-forging. The principle of this method differs only in appearance. The wire rope is enclosed with the help of a sleeve. There is a cavity in the sleeve into which the lubricant is pressed under high pressure. Excess lubricant is removed at the end using a scraper.

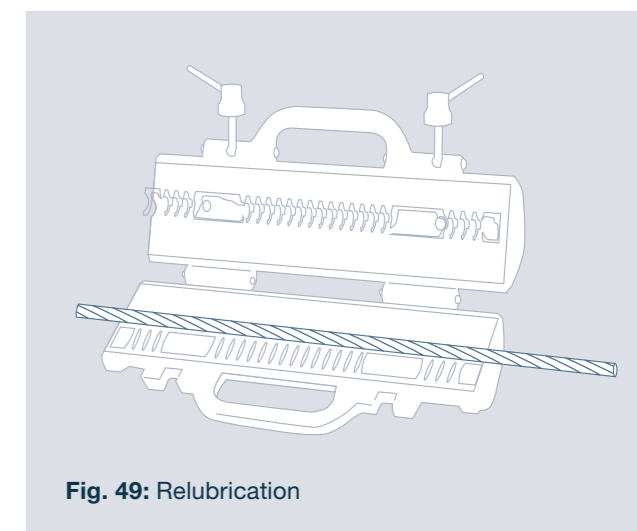

Fig. 49: Relubrication

Many applications, such as container gantry cranes, have automatic re-spraying devices that continuously re-grease the wire rope. This type of relubrication is used when the system cannot be shut down for time or cost reasons or when the need for lubricant is increased. This application can be retrofitted by specialized companies without any problems. companies. Another cost-effective method is

manual application. Here, either atomizer systems using compressed air can be used, or simple tools such as brushes or soaked cloths can be used. With this method, care must be taken to ensure even application.

Both too much and too little lubricant are counterproductive. The best effect is achieved with a very even film of lubricant. Lubricants are also available in aerosol cans for re-preservation. The practical aerosol cans allow an even mist to be applied to the wire rope. The propellant gas in

the can evaporates, leaving pure lubricant on the wire rope. verope® also offers a lubricant in aerosol cans for special wire ropes. Our verolube® can be purchased on request.



!! Heated wire rope lubricant can cause injuries !!

### 7.3 Removal of ends of broken wires

With some wire breaks, the broken wire may protrude from the wire rope. This wire can damage neighboring wires when it runs over the sheave again, causing secondary wire breaks. By using pliers and continuously bending the

protruding wire back and forth, it can be removed and no longer poses a risk to neighboring wires.



!! Protruding wires can cause injuries !!

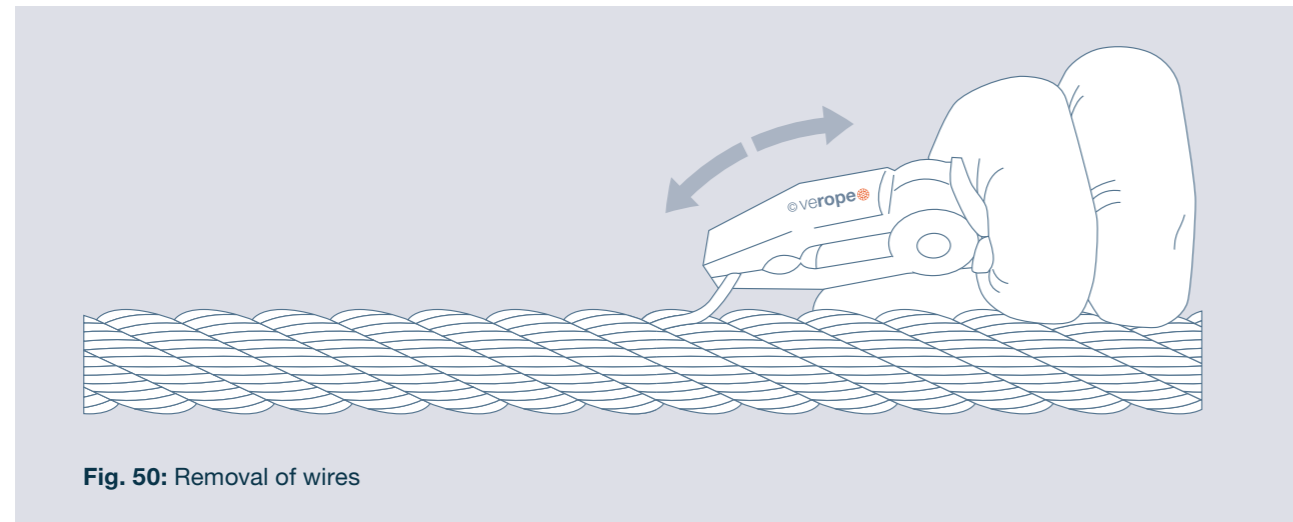

Fig. 50: Removal of wires

### 7.4 Replacing the wire rope / dismantling Decommissioning

A wire rope must be replaced by qualified or authorized persons in compliance with the applicable regulations.

#### Disassembly

- Improper disassembly can lead to injuries.
- May only be carried out by suitably qualified personnel.
- Only qualified specialist personnel who are familiar with the ISO 4309 and EN 12385 standards standards may decommission wire ropes or systems.

- The following knowledge is also required:
  - Safety regulations concerning wire ropes
  - Assembly and disassembly instructions

#### Special protective measures when dismantling wire ropes

! when removing damaged wire ropes, these can tear during replacement / exchange.

! when removing worn wire ropes with damaged / protruding wires

! permanent deformations or twisted parts can lead to injuries.

! verope® special wire ropes, which work with plastic wire rope pulleys or non-metallic wire rope pulleys, have special discard criteria. Check the information in the user manual for the system or contact the manufacturer.

! Note the data and the reason for replacement on the product certificate.

! Keep discarded wire ropes in a safe place and label them so that they are no longer used.

! Dispose of the wire rope in accordance with local regulations.

## 8 TRACKING

We are legally obliged to monitor our wire ropes even after delivery.

This applies in particular to the following aspects:

- Have there been any changes to the wire rope design?
- Have production parameters been changed?
- Are there any experiences with the wire ropes that could be important for other users?
- Are there any malfunctions / failures?
- Are there any abusive applications?
- Are there any difficulties with the operating instructions?

Please let us know what could be important for us.

Simply use the following form and send it to [sales@verope.com](mailto:sales@verope.com)



**You can fill out the form online here**

[www.verope.com/formblatt/](http://www.verope.com/formblatt/)

If you have any questions or comments, please contact verope® AG – e-mail: [Info@verope.com](mailto:Info@verope.com).



St. Antons Gasse 4a  
CH-6300 Zug ZG  
Switzerland  
Tel.: +41 58 588 80 880

*Tinn Rnm*

Zug / CH, in October 2024